

DOB III AC Module D47 120V COB Type Series

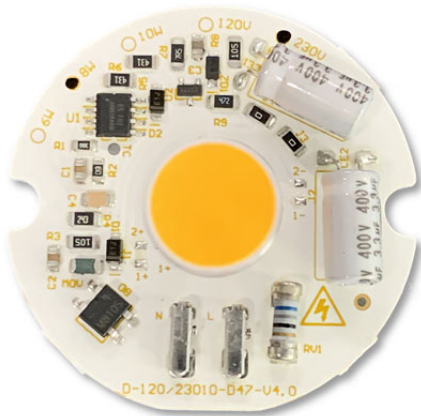

Application



Down Light



Spot Light



PAR Lamp

Product Description

6W/8W/10W Power Consumption

AC 120V Voltage input

Module Diameter 47mm

LES Diameter 16mm

Features

High color rendering index CRI(Ra) > 80/90

Small color tolerance MacAdam < 3

TRIAC dimming compatible

Uniform Full dimming

High Power Factor > 0.9

Low EMI

RoHS compliant

No photo-biological hazard: RG1

Percent flickering < 30%

Pass Title24 requirement

Benefits

Module with integrated electronic

Enables thin designs of luminaries

Table of Contents

General Information.....	3
Absolute Maximum.....	4
Luminous Flux Characteristic (Tc=25°C).....	5
Chromaticity Coordinates (Tc=25°C).....	7
Mechanical Dimensions	8
Holder Dimensions	9
Characteristic curve.....	10
Reliability	14
Product Packaging Information	15
Handling with a DOB	16
Revision History	19
About Edison Opto	19

General Information

Ordering Code Format

<u>5</u>	<u>DAT</u>	<u>C</u>	<u>N</u>	<u>90</u>	<u>23</u>	<u>10</u>	<u>XX</u>	<u>XX</u>	
X1	X2-X4	X5	X6	X7-X8	X9-X10	X11-X12	X13-X14	X15-X16	
X1	X2-X4		X5		X6		X7-X8		
Item	Module application		Dimensions		IC		CRI		
5	Module	DAT	DOB dim	C	Circle	-	-	90	90
								80	80

X9-X10	X11-X12		X13-X14		X15-X16		
Voltage	Power Consumption		Emitting color		Serial Number		
12	120V	06	6W	27	2700K	-	-
23	230V	08	8W	30	3000K		
		10	10W	40	4000K		
				57	5700k		
				65	6500k		

Absolute Maximum

Parameter	Symbol	Value	Units	Units
Maximum operation voltage	V_{op}	144	V	-
Power Dissipation	P_d	6.6 / 8.8 / 11	W	$V_{op}=120V$
Operation ambient temperature	T_a	-40~+85	°C	$V_{op}=120V$
Storage temperature	T_{st}	-40~+100	°C	
Case Temperature	T_c	85	°C	$V_{op}=120V$
Insulation voltage	Viso[RMS]	1.5	KV	
Tolerance of Surge	V_s	1.5	KV	$V_{op}=120V$



Lighting Design Manufacturing Service

Luminous Flux Characteristic (T_c=25°C)

Order Code	CCT (K)	Luminous Flux(lm) T _c =25°C		Efficacy (lm/W)	CRI Ra	LES (mm)	Vac	Watt
		Min.	Typ.	Typ.	Typ.	Typ.	Typ.	
5DATCN8012062704	2700	510	570	95	80	16	120	6
5DATCN8012063004	3000	510	570	95				
5DATCN8012064004	4000	540	600	100				
5DATCN8012065704	5700	540	600	100				
5DATCN8012066504	6500	540	600	100				
5DATCN9012062704	2700	460	510	85	90	16	120	6
5DATCN9012063004	3000	460	510	85				
5DATCN9012064004	4000	485	540	90				
5DATCN9012065704	5700	485	540	90				
5DATCN9012066504	6500	485	540	90				

Order Code	CCT (K)	Luminous Flux(lm) T _c =25°C		Efficacy (lm/W)	CRI Ra	LES (mm)	Vac	Watt
		Min.	Typ.	Typ.	Typ.	Typ.	Typ.	
5DATCN8012082704	2700	685	760	95	80	16	120	8
5DATCN8012083004	3000	685	760	95				
5DATCN8012084004	4000	720	800	100				
5DATCN8012085704	5700	720	800	100				
5DATCN8012086504	6500	720	800	100				
5DATCN9012082704	2700	576	640	80	90	16	120	8
5DATCN9012083004	3000	576	640	80				
5DATCN9012084004	4000	612	680	85				
5DATCN9012085704	5700	612	680	85				
5DATCN9012086504	6500	612	680	85				

Order Code	CCT (K)	Luminous Flux(lm) T _c =25°C		Efficacy (lm/W)	CRI Ra	LES (mm)	Vac	Watt
		Min.	Typ.	Typ.	Typ.	Typ.	Typ.	
5DATCN8012102704	2700	810	900	90				
5DATCN8012103004	3000	810	900	90				
5DATCN8012104004	4000	855	950	95	80			
5DATCN8012105704	5700	855	950	95				
5DATCN8012106504	6500	855	950	95				
5DATCN9012102704	2700	720	800	80	90	16	120	10
5DATCN9012103004	3000	720	800	80				
5DATCN9012104004	4000	735	850	85				
5DATCN9012105704	5700	735	850	85				
5DATCN9012106504	6500	735	850	85				

Parameter	Symbol	Min.	Typ.	Max.	Units	Condition
Viewing Angle FWHM	2θ1/2		120		deg	Vop=120V
Operation Voltage	V _{op}	108	120	132	V	Vop=120V
Power Dissipation	P _d	5.4	6	6.6	W	Vop=120V
		7.2	8	8.8		
		9	10	11		
Operation Frequency	Fop	50 / 60			Hz	Vop=120V
Power Factor	PF	0.9			-	Vop=120V
Current THD	ATHD	-	30		%	Vop=120V
Flicker	-	-		30	%	Vop=120V

Notes:

1. At 120Vac, T_c=25°C
2. Edison Opto Corp. maintains luminous flux ±10%, Ra and R9±2 tolerance.

Chromaticity Coordinates (Tc=25°C)

.CIE chromaticity Diagram

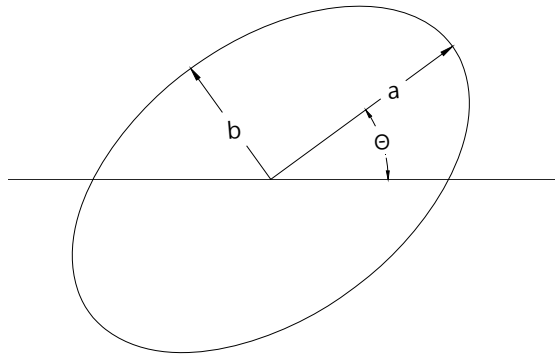

The color ranks have chromaticity ranges within 3-step MacAdam ellipses

CCT	Steps	Cx	Cy	a	b	theta
2700K	3	0.4578	0.4101	0.00810	0.00420	53.70
3000K	3	0.4338	0.4030	0.00834	0.00408	53.22
4000K	3	0.3818	0.3797	0.00939	0.00402	53.72
5700K	3	0.3287	0.3417	0.00746	0.00320	59.09
6500K	3	0.3123	0.3282	0.00669	0.00285	58.57

Note:

Tolerance of measurements of the chromaticity coordinate is ± 0.005 .

Emitter Dimensions

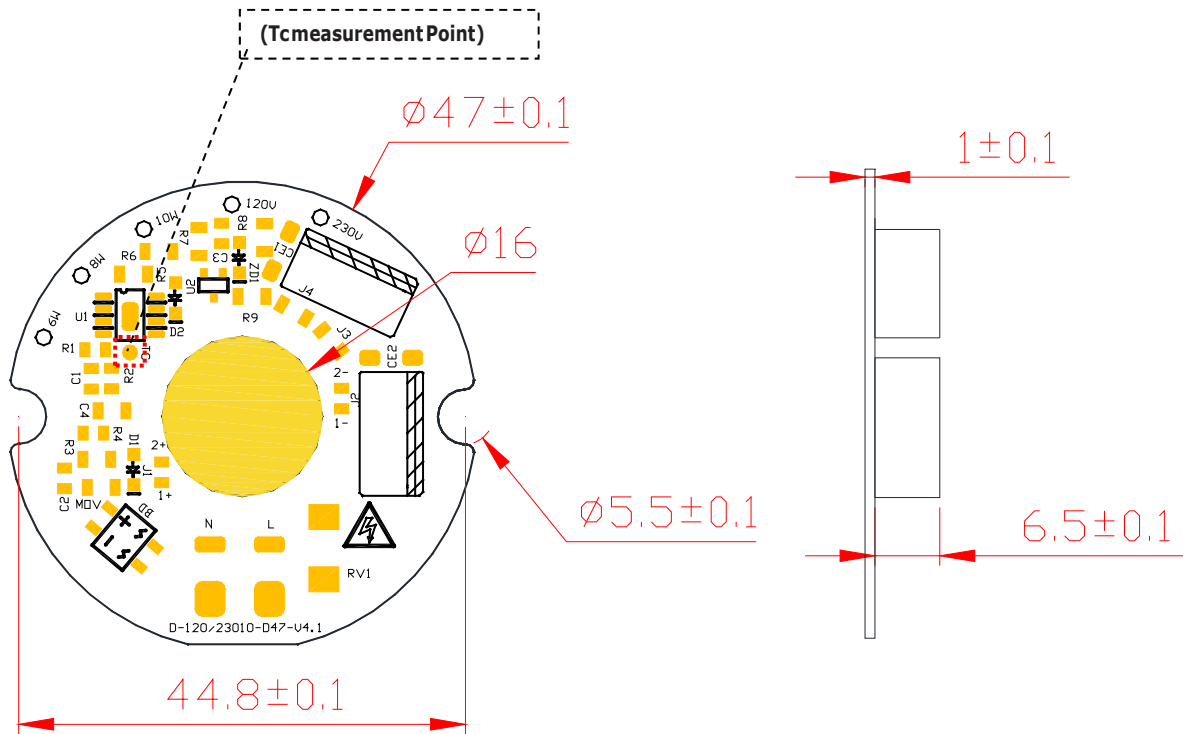

Note : Unit : mm

Holder Dimensions

Product description

1. Material : PC
2. Color : White/Black
3. Flame retardant rating : V0

D47-White



D47-Black

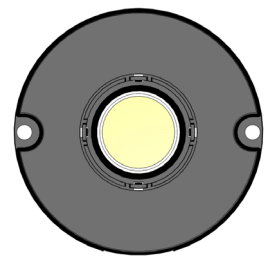

Application Note

1. Operating temperature: $-40^{\circ}\text{C} \sim 120^{\circ}\text{C}$
2. Apply on DOB D47 Series
3. M3 screws with flat head, max. head diameter should be no more than 6mm

Product Dimension

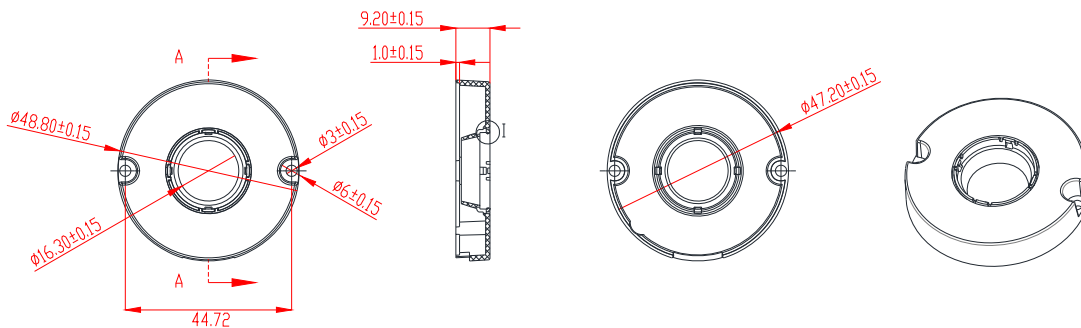

Ordering Data

Part No	Color	Packaging Bag	Weight per pc.
13CR5ELACN04	white	1,500 pcs	0.004kg
13CR5ELACN05	black	1,500 pcs	0.004kg

Characteristic curve

Color Spectrum (Tc=25°C, VAC=120V)_Ra 80

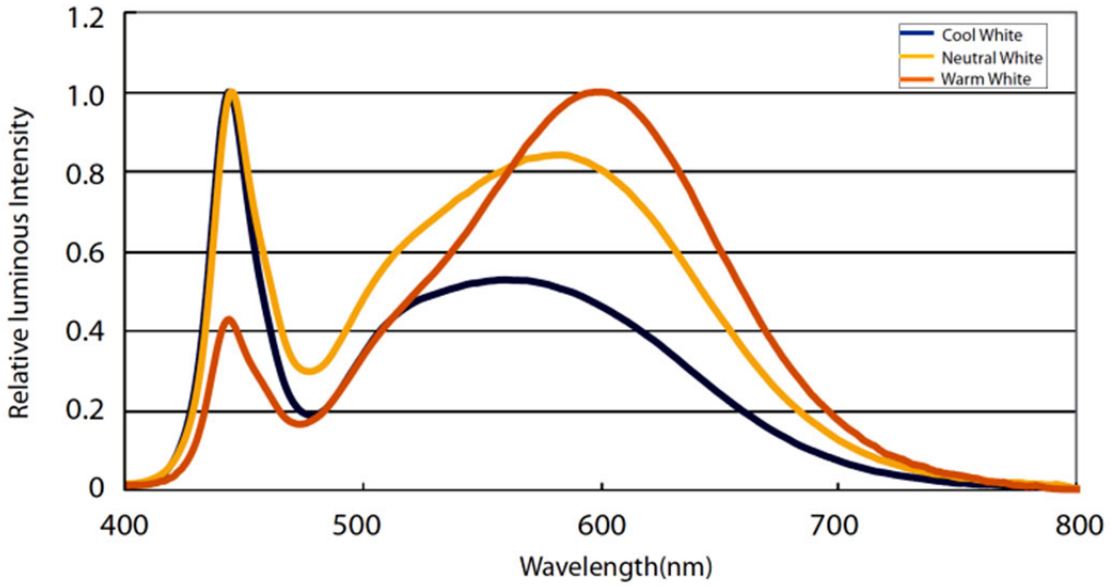

Color Spectrum (Tc=25°C, VAC=120V)_Ra 90

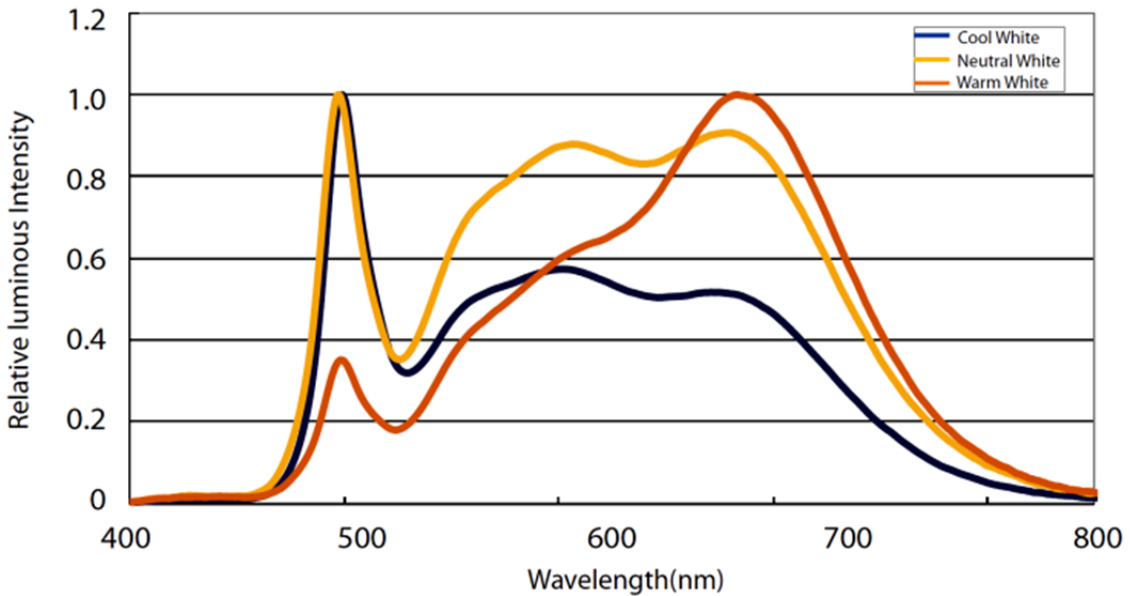

Beam Pattern

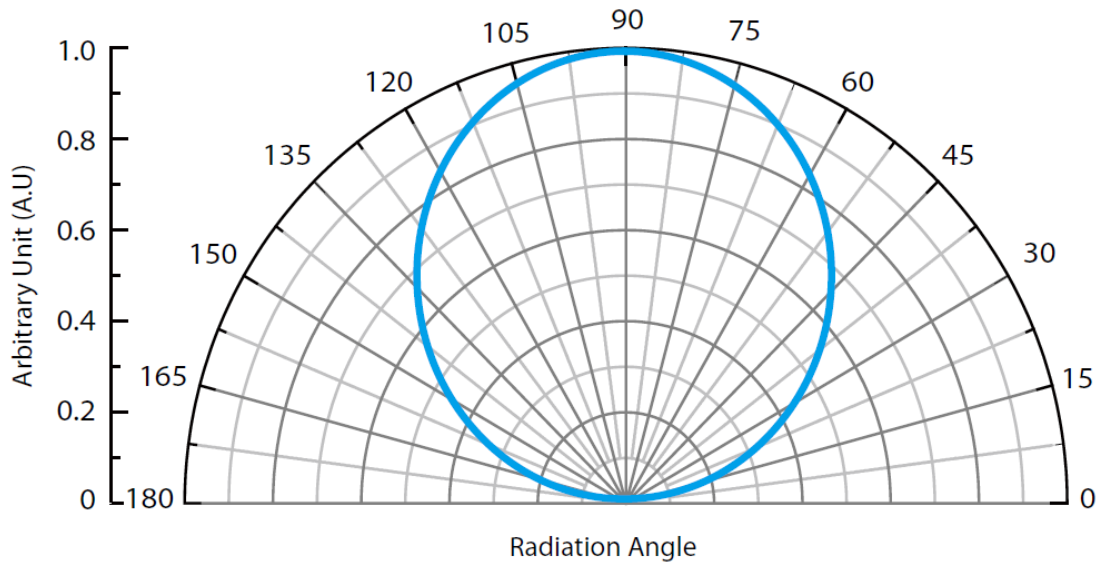

Relative luminous Intensity vs. Voltage (Tc=25°C)

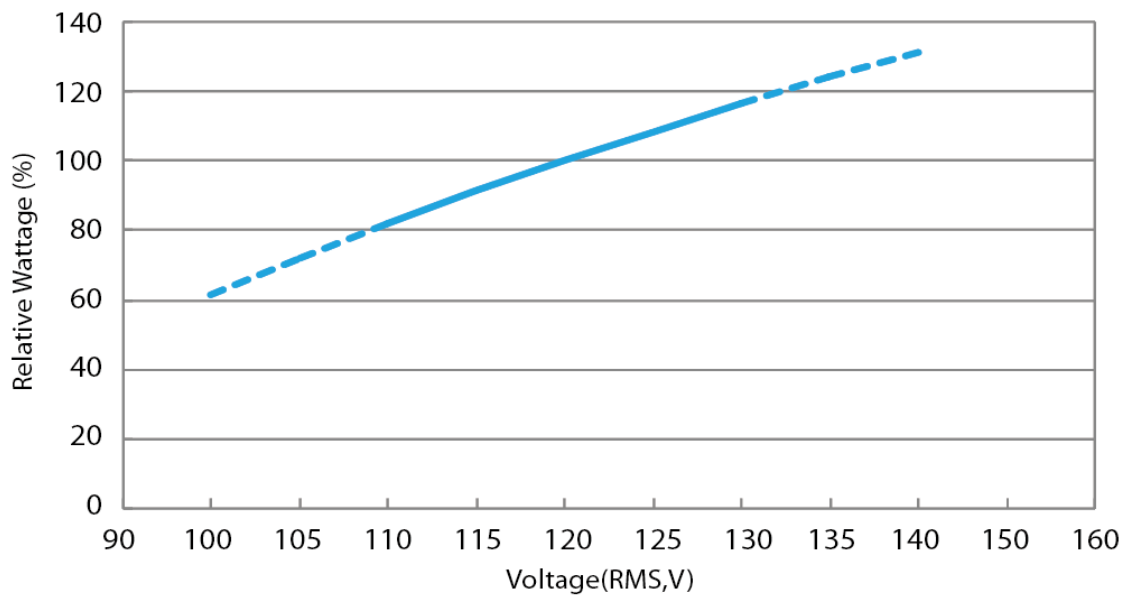

Wattage vs. Voltage (Tc=25°C)

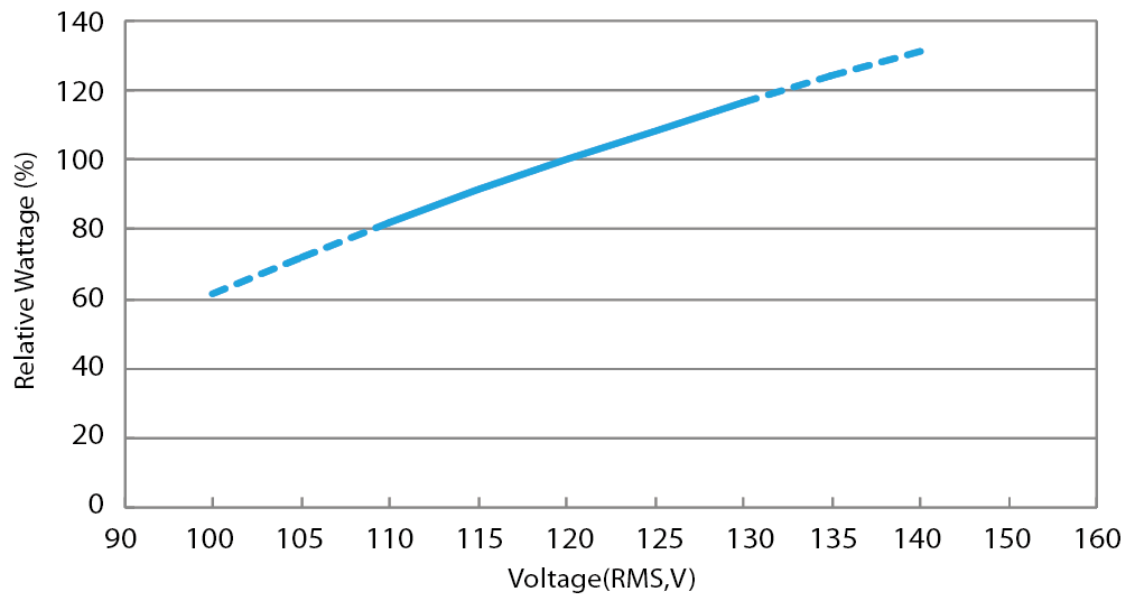

Relative Luminous Flux vs. Case Temperature (VAC=120V)

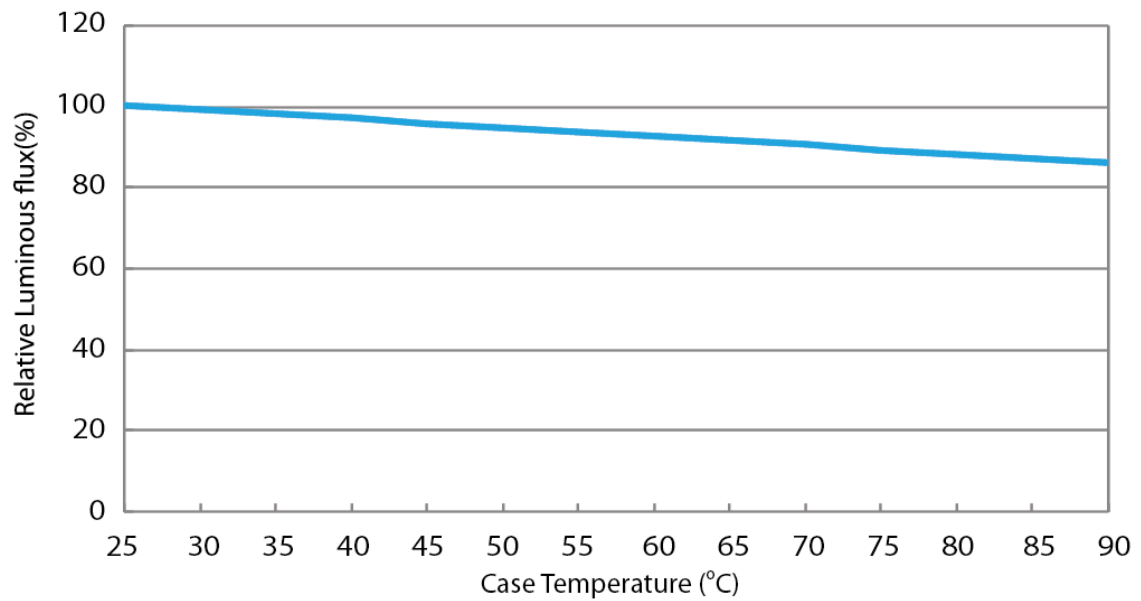

Wattage vs. Case Temperature (VAC=120V)

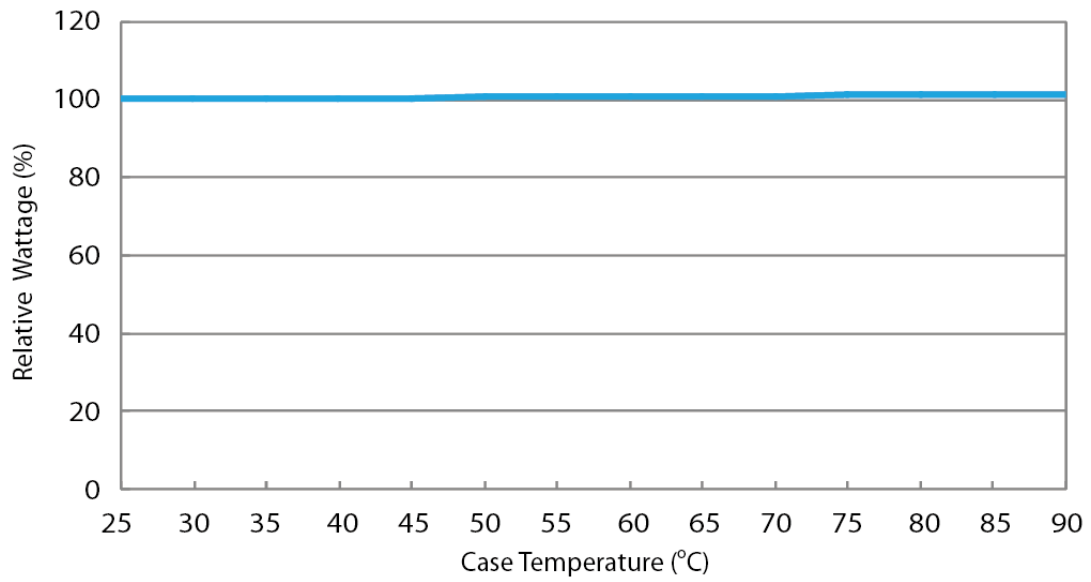

Reliability

NO .	Test Item	Test Condition	Remark
1	Temperature Cycle	-40°C~100°C (30 mins / 30 mins)	100 Cycle
2	Operation Life test	T _a = 25°C	1000 hrs
3	ON/OFF Test	3 sec ON, 3 sec OFF	15K times

Failure Criteria

Item	Criteria for Judgment	
	Min.	Max.
Luminous Flux	0.85	-
$\Delta u'v'$	-	0.006
Resistance to Soldering Heat	No dead lamps or visual damage	

Cautions

LED avoids being stored and lighted in the environment containing sulfur. Some materials, such as seals, printing ink, enclosure and adhesives, may contain sulfur, avoiding the exposure in acid or halogen environment.

Product Packaging Information

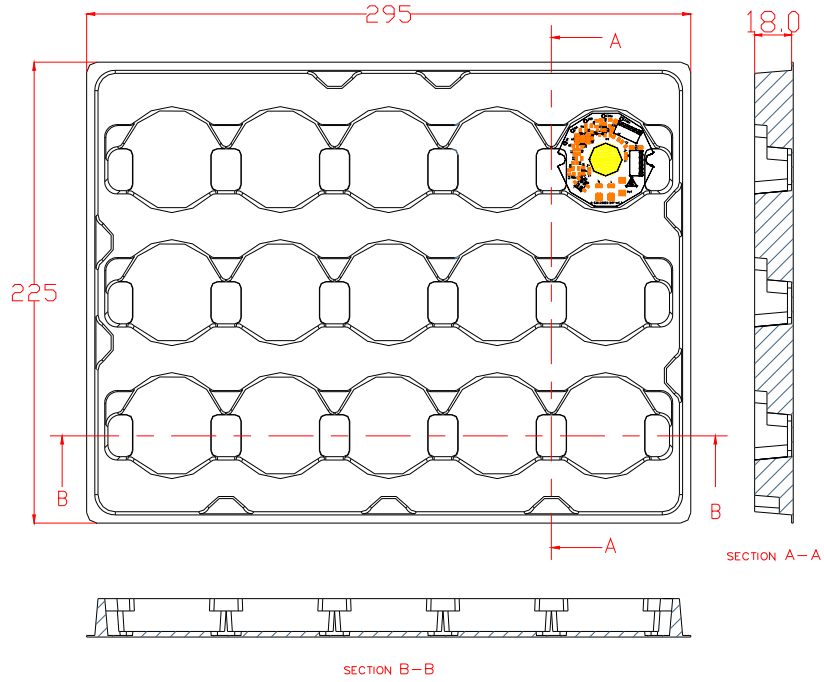

Tray:295x225x18mm, 15pcs module in the Tray

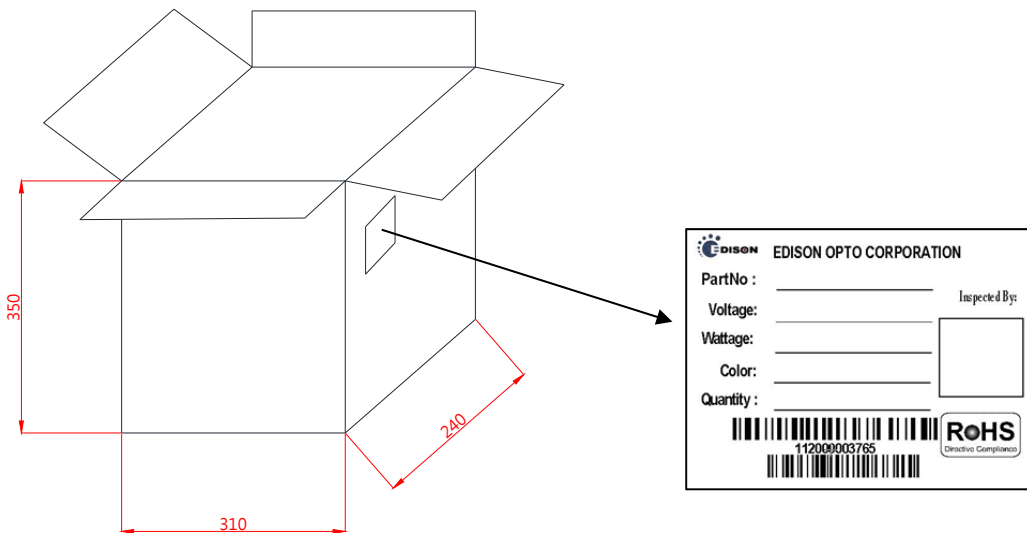

33 Tray in the outer box,495 pcs module in the outer box

Part No.	Number of module/Tary	Number fo module / Box	Weight
5DATCNx012xxxx04	15pcs	495pcs	5.2KG

Handling with a DOB

- √ Both the light emitting area and white dam over the light emitting area is composed of resin materials. Please avoid the resin area from being pressed, stressed, rubbed, come into contact with sharp metal nail because the function, performance and reliability of this product are negatively impacted.

- √ LED device are combine by many accurate parts which belong to static sensitive device. A human body may aware of the discharge voltage about 2-3KV, which is much larger than an electronic device may bear. Therefore, to keep the LED operation environment away from static and lower the exits static become an important issue in a LED manufacture.
 1. Anti-Static Steps - All the staffs who have the possibility to contact with the LED components should follow the instructions to eliminate the static:
 - Put on the hand or finger gloves before touch a LED device. (Do not use a nylon or rubber Glove)
 - Do not do any actions that may generate the static in the protection area. Such as wipe hands or foot, put on/off the clothes.
 - Avoid any movement that may cause static damages. When remove a component from the package, please be slow and gentle.
 - Do not touch the metal part of a LED component.

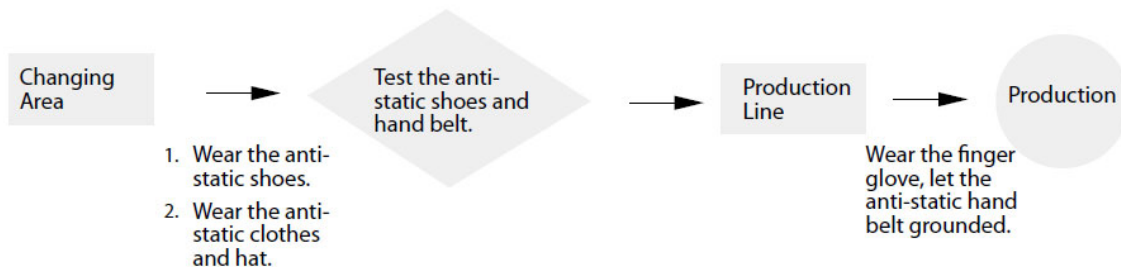

2. Environmental anti-static protection

- Use an anti-static floor and make earth. Materials such as plastic or rubber contain carbon or conductive polyester is recommended.
- LEDs should be operated on the desk which is laid by the static discharge material.
- Protect area with a temperature at $22\pm 5^{\circ}\text{C}$ and relative humidity at $70\pm 10\% \text{RH}$ are recommended.
- Layout an appropriate earth system. All the equipment should earth isolated into the ground or pillar.
- All soldering and testing equipment should also provide earth ability.
- Prevent the accumulation and the fractions between stuffs.

3. Anti-Static steps for package, transportation and storage

- Package: All the bags must have the ability of anti-static. Do not use any nylon bag, normal plastic bag or polyester bag for package. Do not open the bag if a LED is not ready to be handling. Open the bag at the protection area and put in a conductive case.
- Transportation: The cart should install the conductive wheels. Avoid the mechanical vibration and impacts.
- Storage: Be attention of the temperature and the relative humidity under the suggest condition.

√ Thermal Management

About 80% of input power of a LED transform into heat. A high temperature operation condition always easily causes the LEDs to decrease of flux and the life decay of LED dies. The highest operation temperature of a component is able to be found in its datasheet which is indicated as T_j .

The power dissipation ability, the ambient temperature between the LED junction, environment, thermal path and its thermal resistance are the mean parameters which affect the performance of a LED device. Therefore, the limitation of the junction temperature has become an important issue when designing a LED product.

For LEDs, choose an appropriate operation environment and conduct the heat to the air after light on LEDs may maintain the better performance and lifetime. Four major thermal path are:

- (1) From heat source (component) to heat sink. (By conduction)
- (2) Conduction from within the heat sink to its surface. (By conduction)
- (3) Transfer from the surface to the surrounding air. (By convection)
- (4) Emit heat from the heat sink surface. (By Radiation)

Path (1): The contact surface of the component and heat sink are not perfectly flat, they are not able to meet each other completely. Air between these two materials will result high thermal resistance and reduce the effect of heat transfer. To enhance the ability of thermal conduction, one common method is applying thermal grease between the two interfaces and use the screws to enforce the adhesion between two surface.

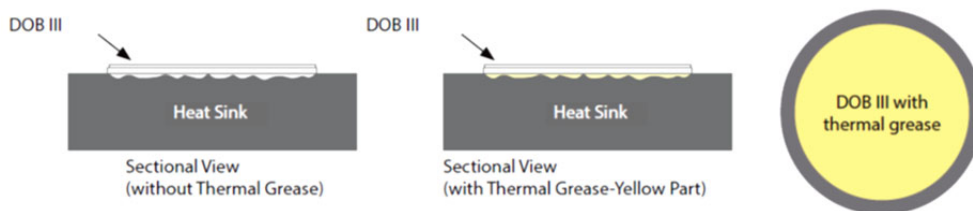

Recommended thermal Grease Parameters

Characteristics	Value	Unit
Thermal Conductivity (K)	> 3.0	W/m*K
Thickness	≤ 0.1	mm

- √ DO NOT touch any of the circuit board, components or terminals with body or metal while circuit is active.
- √ DO NOT add or change wires while circuit is active.
- √ DO NOT make any modification on module.
- √ DO NOT use together with the materials containing sulfur.
- √ DO NOT exceed the values given in this specification
- √ Keep cautions not to apply higher voltage above the maximum rating. Otherwise damage may occur.
Pay attention not to exceed the maximum operation temperature of the Tc Point when the modules are used in an enclosed environment.
- √ DO NOT use adhesives to attach the LED that outgas organic vapor.
- √ DO NOT directly make the HI-POT test over 750V on the module.
- √ DO NOT separately connection L and N terminal when the power source turn on
- √ DO NOT wear any conductive accessories (such as jewelry) which could accidentally get an electric shock.
- √ DO NOT press the product; even a slight pressure may damage the product. The environments such as high temperatures, high humidity or direct expose to sunlight should be avoided since the product is sensitive to these conditions
- √ DOB AC Module uses integrated circuit (IC) which can be damaged when exposed to static electricity. Please operate with antistatic device. Do not touch the product unless ESD protection is used. DOB AC Module can't be installed in end product unless the ESD protection is used
- √ DO NOT assemble in conditions of high moisture and/or oxidizing gas such as Cl, H₂S, NH₃, SO₂, NO_x, etc. Damage by corrosion will not be allowed as defect claim.
- √ LED Module is recommended for Indoor use only. Longtime exposure to sunlight or UV can cause the lens to discolor.
- √ Please note that BOB AC Module products are driven by high voltage, therefore when operating DOB AC Modules should be very cautious
- √ Faults, lightning, or fast switch may cause voltage surge which surpasses the normal value
- √ The failure of internal component may cause excessive voltages
- √ Storage Precautions:
 - (1) The devices should be stored in the anti-static bag.
 - (2) If the anti-static bag has been opened, please make sure to reseal the bag to avoid air and moisture infiltrate in the bag.

Revision History

Versions	Description	Release Date
1	Establish a Datasheet	2021/06/17

About Edison Opto

Edison Opto is a leading manufacturer of high power LED and a solution provider experienced in LDMS. LDMS is an integrated program derived from the four essential technologies in LED lighting applications- Thermal Management, Electrical Scheme, Mechanical Refinement, Optical Optimization, to provide customer with various LED components and modules. More Information about the company and our products can be found at www.edison-opto.com

Copyright©2021 Edison Opto. All rights reserved. No part of publication may be reproduced or transmitted in any form or by any means, electronic or mechanical, including photo copy, recording or any other information storage and retrieval system, without prior permission in writing from the publisher. The information in this publication are subject to change without notice.

www.edison-opto.com

general assistance please contact:
service@edison-opto.com.tw

technical assistance please contact:
LED.Detective@edison-opto.com.tw