

LightMAX

R0349

32 power LED module



7 YEARS WARRANTY

CC CONSTANT CURRENT



FEATURES

- PCB dimension: 164x151mm
- Up to 16700 lm
- Up to 188 lm/W
- CRI70
- Max Electrical Insulation 250V
- Max 2 LED boards in series
- Connection type: S-Poke 4mm 2 pole
- Lifetime > 100.000h @ 700mAi_{if}<math><1050\text{mA}</math> L90B10

APPLICATIONS



Street



Industrial

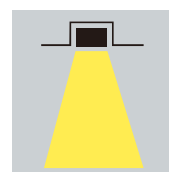

Downlight

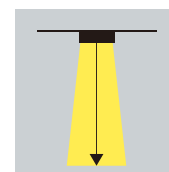

High Bay

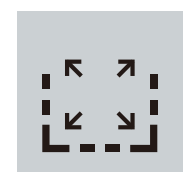

Area

LightMAX

R0349

32 power LED module



7 YEARS WARRANTY

CC CONSTANT CURRENT

Code	CCT	CRI	Current [mA]	Voltage [V]	Power [W]	Total Lumen [lm]	Lm/W	Energy Efficiency
R0349012770	2700K	70	700	91,52	64,06	11097	173	C
			1000	94,72	94,72	15410	163	D
R0349013070	3000K		700	91,52	64,06	11467	179	C
			1000	94,72	94,72	15923	168	D
R0349014070	4000K		700	91,52	64,06	12022	188	C
			1000	94,72	94,72	16700	176	C
R0349015070	5000K		700	91,52	64,06	12022	188	C
			1000	94,72	94,72	16700	176	C

*Lux tolerance +/- 10%
 **Voltage +/- 0.5Vall

Ask for more information about available LED and other options.

LED and board features	
LED number	32
LED type	5C5C
Circuit	S16P2
Material	MCPCB
Solder	WHITE OR MATT BLACK (on request)
Connections	
Cable	Solid 0,2-0,8mm ² Strand 0,45-0,7mm ²
Connector	1x S-Poke 4mm 2 pole
Power	
Ass. Max. input current CC	1400mA
Mechanical Data	
H x L	164x151
Thickness	5,55mm
Conditions	
Max. temp. (T _o)	100°C
Max. temp. (T _c)	95°C
Operating temp. Range	-25°C - 155°C

LightMAX

R0349

32 power LED module



7 YEARS WARRANTY

CC CONSTANT CURRENT

MECHANICAL DRAWING

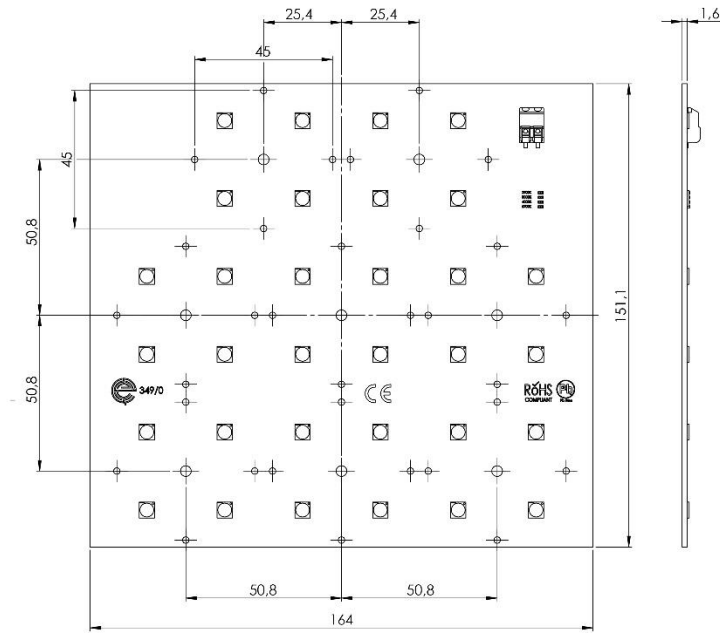

ELECTRICAL CIRCUIT

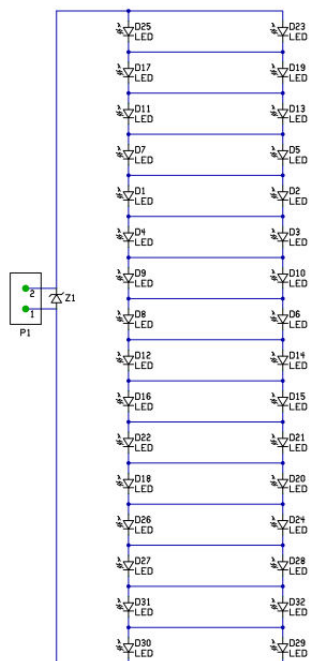

LightMAX

R0349

Accessories: LedLink Optics lens



7 YEARS WARRANTY

CC CONSTANT CURRENT



Specifications: BXJ series	
View Angle (Fwhm)	60°/90°/80°x150°/45°x155°/95°x165°/65°x165°
Material	L02: PC LEV 700 - L19: PC 1250Z - L52: PC 2180T
Type	4 in 1
Efficiency	88% ~ 93%
Operating Temperature	-40°C ~ 110°C

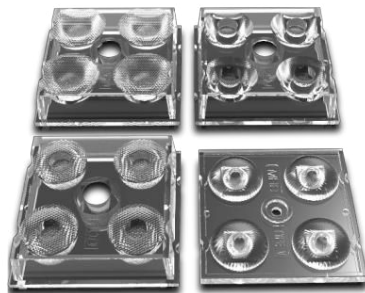

Specifications: CXR series	
View Angle (Fwhm)	25°/40°/60°/165°/20°x60°
Material	L06: PMMA 8N - L52: PC LUX 218CT
Type	4 in 1
Efficiency	90% ~ 91%
Operating Temperature	PMMA: -40°C ~ 170°C - PC: -40°C ~ 110°C

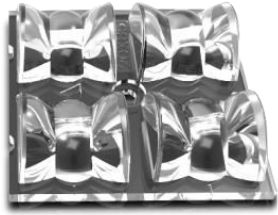

Specifications: DBJ series	
View Angle (Fwhm)	20°x90°
Material	L06: PMMA 8N - L52: PC LUX 218CT
Type	4 in 1
Efficiency	90% ~ 91%
Operating Temperature	PMMA: -40°C~+70°C - PC: -40°C~+110°C

ASSEMBLY AND SAFETY INFORMATION

Installation must be carried out under observation of the relevant regulations and standards. The LED modules are designed for operation within a casing or luminaire. Installation must be carried out in a voltage-free state (i.e. disconnected from the mains).

The following advice must be observed; non-observance can result in the destruction of the LED assembly modules, fire and/or other hazards.

- o Consider safety regulations acc. EN 60598 in the luminaire design, especially when the operating LED driver is not galvanically isolated.
 - In mode of operation regard to sufficient isolation.
 - Live parts must not be touched in operation mode. Danger in life!
- o ESD (electrostatic discharge) protection measures must be observed when handling and installing the LED modules. See VS's application notes on ESD protection.
- o Adequate anti-static electricity measures, including the use of conductive shoes, ionizers, work bench grounding, wrist straps, flooring and stools should be used.
- o LED assembly modules must not be subjected to any undue mechanical stress, e.g.:
 - do not treat as bulk cargo
 - avoid shear and compressive forces during handling and installation
 - do not damage circuit paths
 - avoid any pressure on the light emitting surface
- o Safe operation only possible by the use of external constant current sources (max. see table 'Electrical Characteristics').
- o Operation only with power supply units that feature the following protection:
 - Short circuit protection
 - Overload protection
 - Overheating protection
- o The module can be fixed with M3 screws. Fixation only with flat or cylinder head screws (M3) (no countersunk screws) Max. torque: 1.2 Nm (M3)
- o Please ensure the correct polarity of the leads prior to commissioning. Reversed polarity can destroy the modules.
- o For interconnection the LED modules is equipped with push-in terminals (WAGO 206C).
- o Safety regulations acc. to EN 60598 (or further standards) has to be observed if the maximum output voltage exceeds the permitted touchable value.
- o The following points must be observed when connecting LED modules in parallel:
 - All LED strings that are wired in parallel must contain the same number of LEDs (symmetrical loading).
 - Owing to differing forward biases, there can be a difference of up to 10% in brightness between modules connected in parallel.
- o To ensure problem-free operation, the specified maximum temperature at the tip point (see 'Operating Life') must be observed (and measured in accordance with EN 60598-1). To satisfy this point, it may be necessary to put measures in place to ensure any heat is dissipated from the PCB to the environment.
- o In the event of outdoor applications or applications in damp locations, care must be taken to protect LED assembly modules against humidity, splashes and jets of water. Any corrosion/damage resulting from humidity or contact with condensation will not be recognized as a defect or manufacturing fault. LED assembly modules are not specially protected against foreign bodies or dust. Depending on the type of application, further protection must be ensured to prevent dust and foreign bodies from entering.
- o Due to the manufacturing process, the PCBs of the LED assembly modules can have sharp edges and corners. Care must therefore be taken during handling and installation to avoid injury.
- o For optimal load of used constant current driver the modules can only be connected in series. The quantity of LED modules is limited by the sum of forward voltage and the capacity of used constant current driver. Safety regulations acc. to EN 60598 has to be observed if the sum of forward voltage exceeds the permitted touchable value.
- o Operating LED modules in the presence of certain chemical substances or in chemically enriched (aggressive) environments can impair module functionality or even cause total module failure.
- o The photobiological safety of the LED modules must be classified into risk groups in accordance with IEC/TR 62778: L_{ns} < group 1 (except HB, 6500 K, > 500 mA: risk group 2

APPLIED STANDARDS

IEC / EN 62031
LED modules for general lighting – Safety specifications

IEC / TR 62778
Application of IEC 62777 for the assessment of blue light hazard to light sources and luminaires