

DOB III AC Module

D34 230V Series

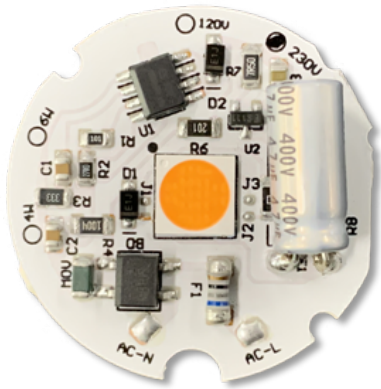

Product Description

4W & 5W Power Consumption
AC 230V Voltage input
Module Diameter 34mm
LES Diameter 6.3mm

Features

High color rendering index CRI(Ra)>80/90
Small color tolerance MacAdam < 3
TRIAC dimming compatible
Uniform Full dimming
High Power Factor > 0.9
Low THDi : 30%
Low EMI
RoHS compliant
No photo-biological hazard : RG1
Percent Flicker <10%
SVM <0.4

Benefits

Module with integrated electronic
Enables thin designs of luminaries

Application



Down Light



Spot Light



PAR Lamp

Table of Contents

General Information.....	3
Absolute Maximum Ratings	4
Optical and Electrical Characteristic (TC=25°C)	5
Chromaticity coordinates(T _c =25°C).....	7
Mechanical Dimensions.....	8
Holder Dimensions.....	9
Characteristic curve.....	10
Reliability.....	16
Product Packaging Information.....	17
Handling with a DOB Series.....	18
Revision History	21
About Edison Opto.....	21

General Information

Ordering Code Format

5 ELA C N 3T 23 XX XX XX
 X1 X2-X4 X5 X6 X7-X8 X9-X10 X11-X12 X13-X14 X15-X16

X1	X2-X4		X5		X6		X7-X8	
Item	Module application		Dimensions		IC		Type	
5	Module	ELA	Edilex AC	C	Circle	-	-	3T EMC

X9-X10		X11-X12		X13-X14		X15-X16	
Voltage		Power Consumption		Emitting color		Serial Number	
23	230V	04	4W	27	2700K	-	-
		05	5W	30	3000K		
				40	4000K		

Absolute Maximum Ratings

Parameter	Symbol	Value	Units	Condition
Maximum operation voltage	V_{op}	253	V	-
Power Dissipation	P_d	4.4/5.5	W	$V_{op}=230V$
Operation ambient temperature	T_{op}	-40~+85	°C	$V_{op}=230V$
Storage temperature	T_{st}	-40~+100	°C	-
Case Temperature	T_C	85	°C	$V_{op}=230V$
Insulation voltage	Viso[RMS]	1.5	KV	-
Tolerance of Surge	V_s	1.5	KV	$V_{op}=230V$

Optical and Electrical Characteristic (TC=25°C)

Order Code	CCT (K)	Luminous Flux(lm) T _c =25°C		Efficacy (lm/W)	CRI Ra	LES (mm)	Vac	Watt
		Min.	Typ.	Typ.	Min.	Typ.	Typ.	
5ELACN3T23042715	2700	340	390	98	80	6.3	230	4
5ELACN3T23043015	3000	360	400	100				
5ELACN3T23044015	4000	380	420	105				
5ELACN3T23042716	2700	315	350	88	90			
5ELACN3T23043016	3000	324	360	90				
5ELACN3T23044016	4000	342	380	95				

Order Code	CCT (K)	Luminous Flux(lm) T _c =25°C		Efficacy (lm/W)	CRI Ra	LES (mm)	Vac	Watt
		Min.	Typ.	Typ.	Min.	Typ.	Typ.	
5ELACN3T23052715	2700	440	490	98	80	6.3	230	5
5ELACN3T23053015	3000	450	500	100				
5ELACN3T23054015	4000	470	525	105				
5ELACN3T23052716	2700	395	440	88	90			
5ELACN3T23053016	3000	405	450	90				
5ELACN3T23054016	4000	420	475	95				

Parameter	Symbol	Min.	Typ.	Max.	Units	Condition
Viewing Angle FWHM	2 θ 1/2		120		deg	Vop=230V
Operation Voltage	V _{op}	207	230	253	V	-
Power Dissipation	P _d	3.6	4.0	4.4	W	Vop=230V
		4.5	5.0	5.5		
Operation Frequency	F _{op}		50/60		H _z	Vop=230V
Power Factor	PF	0.9	-	-	-	Vop=230V
Current THD	ATHD	-	30	-	%	Vop=230V
Flicker	-	-	5	10	%	Vop=230V
DF	-	0.9	-	-	-	Vop=230V

Notes:

1. At 230Vac, Ta=25°C.
2. Edison Opto Corp. maintains luminous flux $\pm 10\%$, Ra ± 2 tolerance.

Chromaticity coordinates($T_c=25^\circ\text{C}$)

CIE Chromaticity Diagram

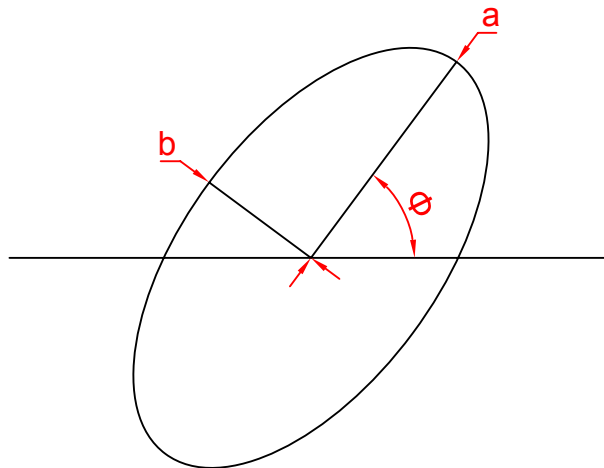

The color ranks have chromaticity ranges within 3-step MacAdam ellipse

CCT	Steps	C _x	C _y	a	b	theta
2700K	3	0.4578	0.4101	0.00810	0.00420	53.70
3000K	3	0.4338	0.4030	0.00834	0.00408	53.22
4000K	3	0.3818	0.3797	0.00939	0.00402	53.72

*Tolerance of measurements of the chromaticity Coordinate is ± 0.005

Mechanical Dimensions

Emitter Dimensions

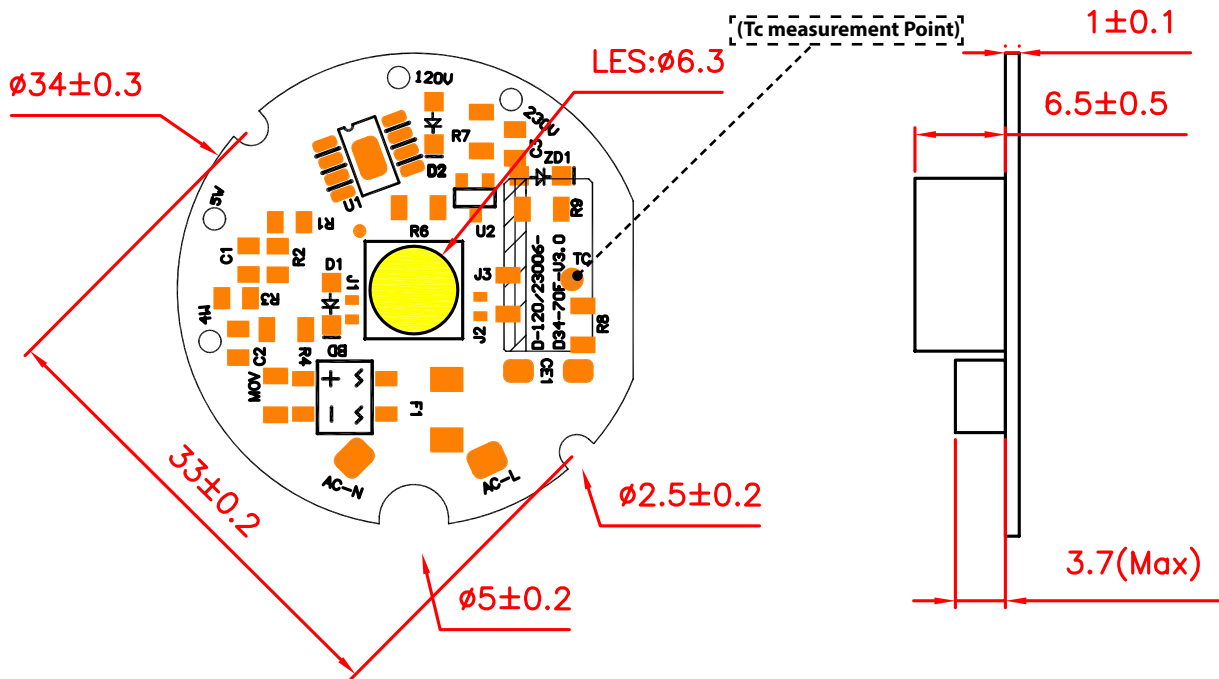

Note :
Unit : mm

Holder Dimensions

Product description

1. Material : PC
2. Color : White
3. Flame retardant rating : V2

D34-White

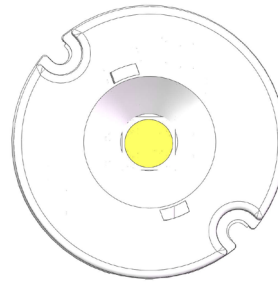

Application Note

1. Operating temperature : $-40^{\circ}\text{C} \sim 120^{\circ}\text{C}$
2. Apply on DOB D34 Series
3. M2.5 screws with flat head , max. head diameter should be no more than 5mm

Product Dimensions

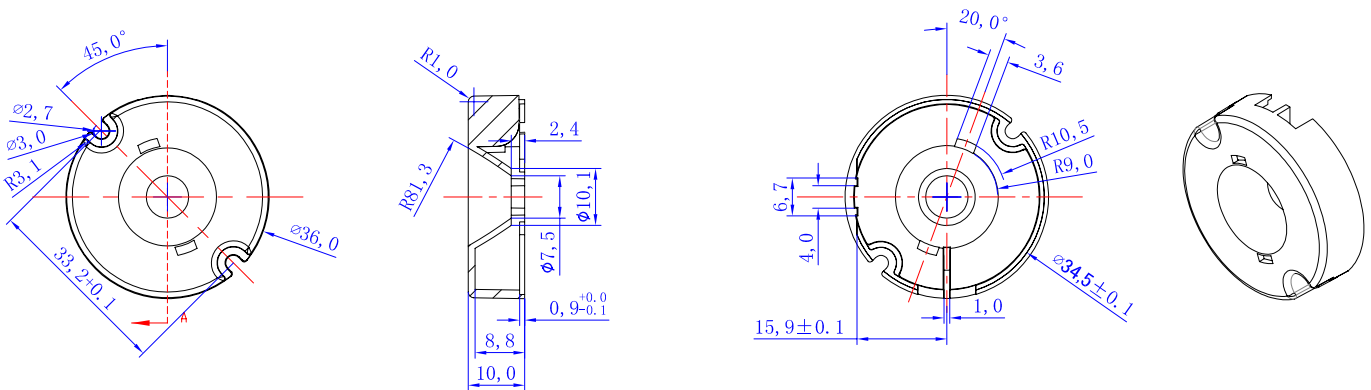

Ordering Data

Part No	Color	Packaging Bag	Weight per pc.
13CRDAA00120	white	200 pcs	0.003 kg

Characteristic curve

Color Spectrum (Tc=25°C,VAC=230V)_Ra 80

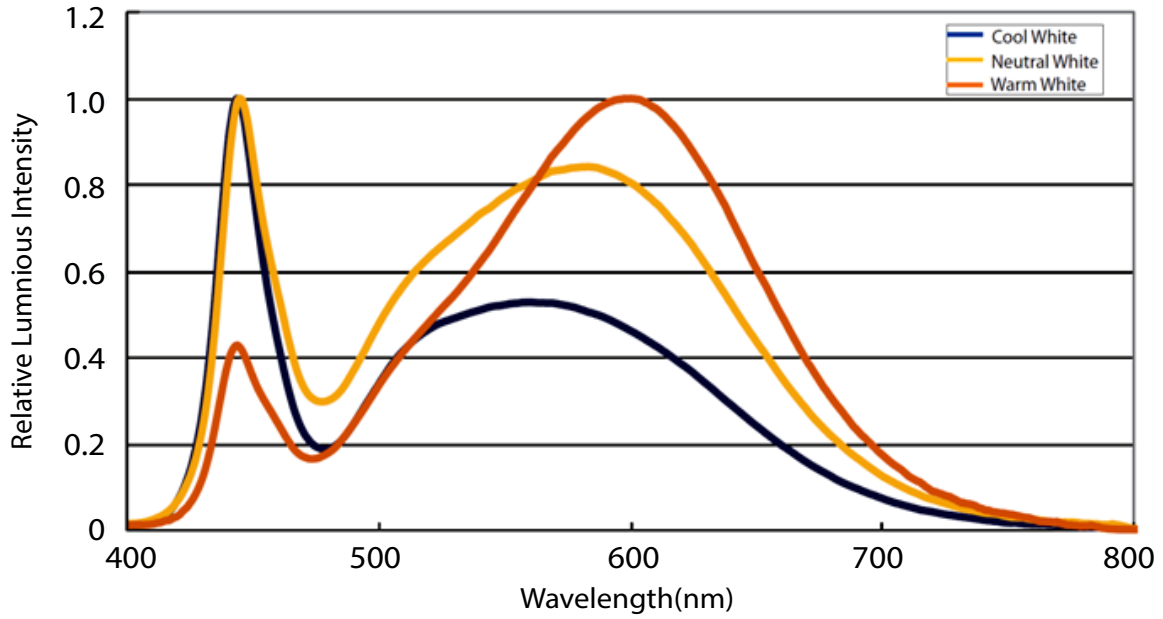

Color Spectrum (Tc=25°C,VAC=230V)_Ra 90

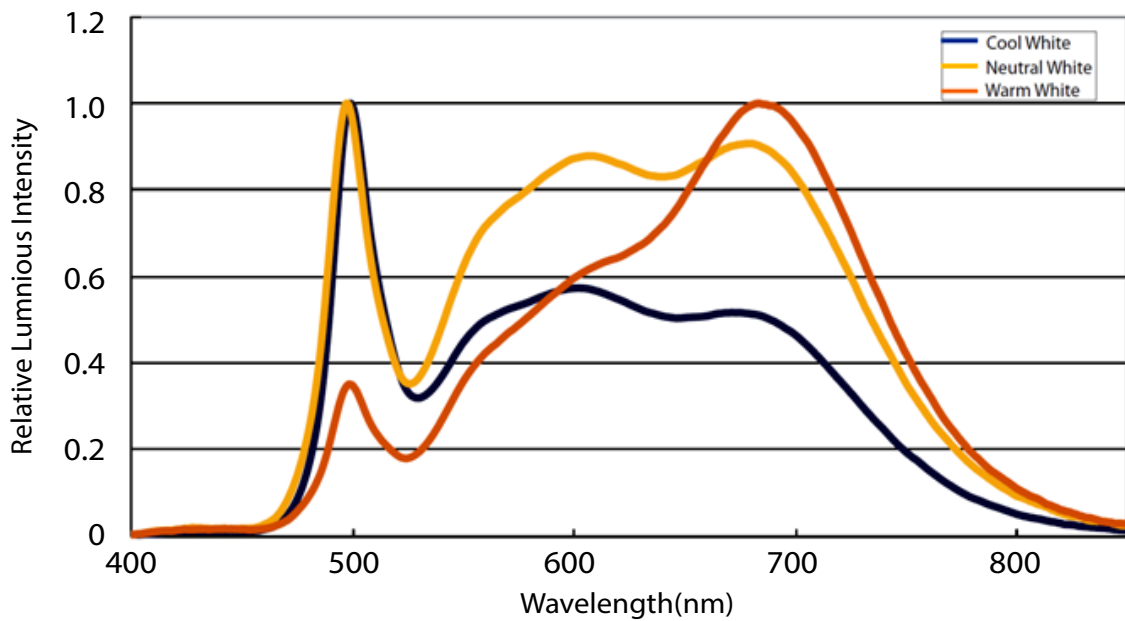

Beam Pattern

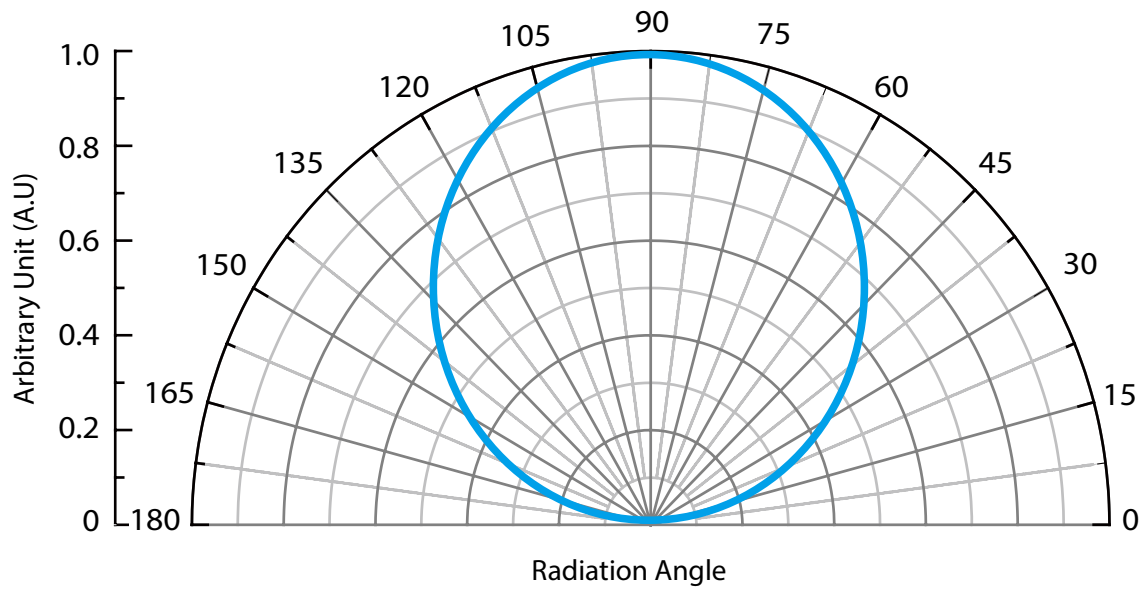

SVM Test (Tc=25°C)

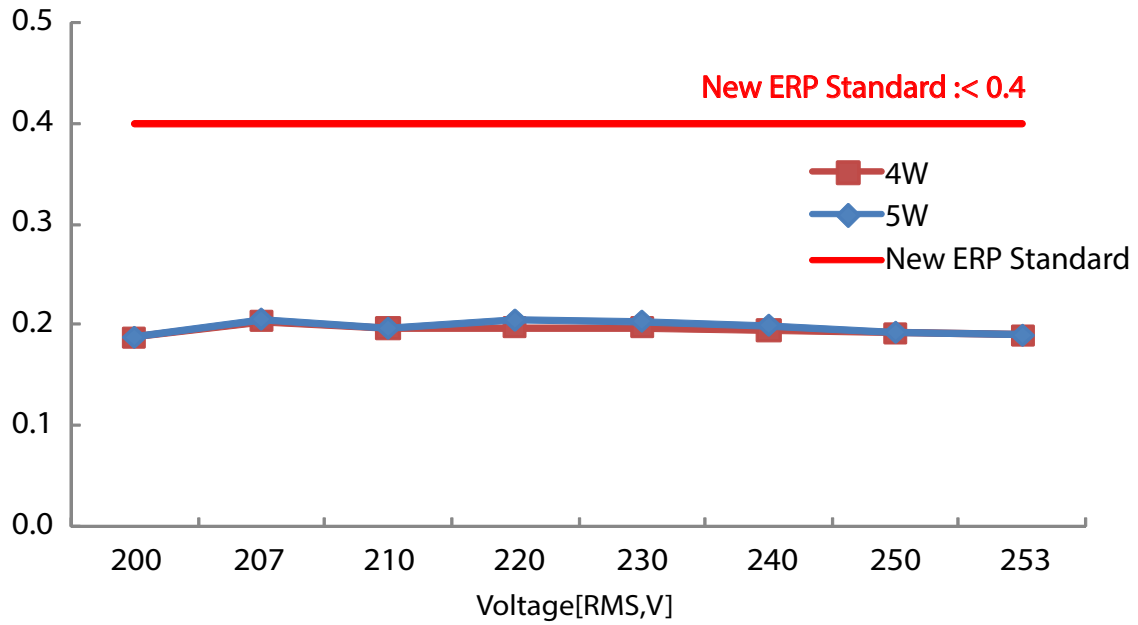

PST Test (Tc=25°C)

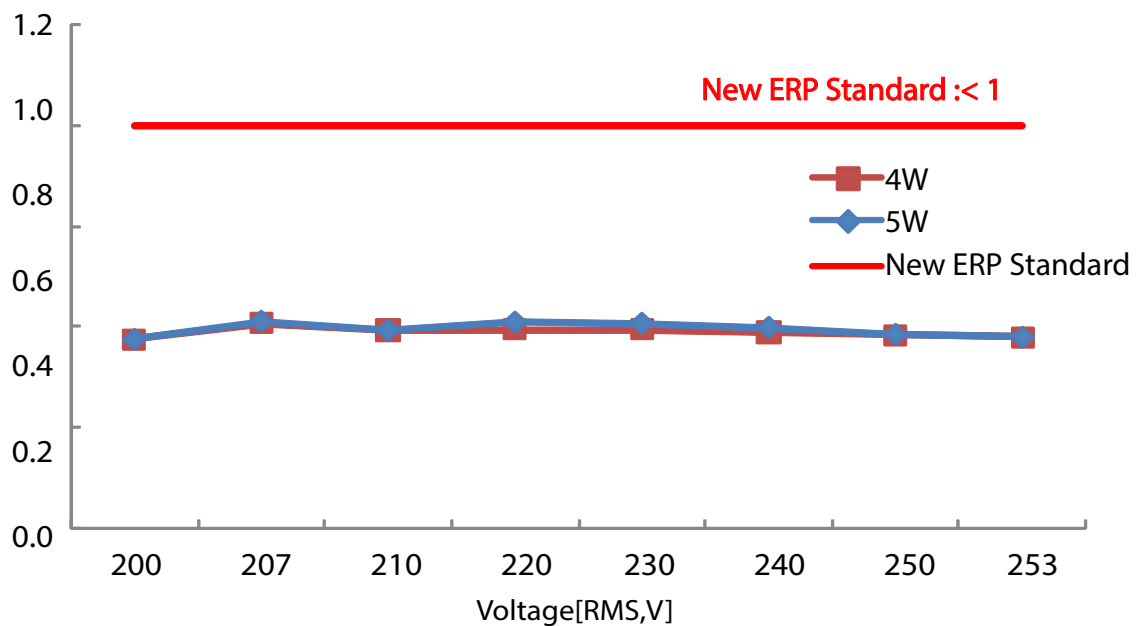

Relative luminous Intensity vs. Voltage (Tc=25°C)

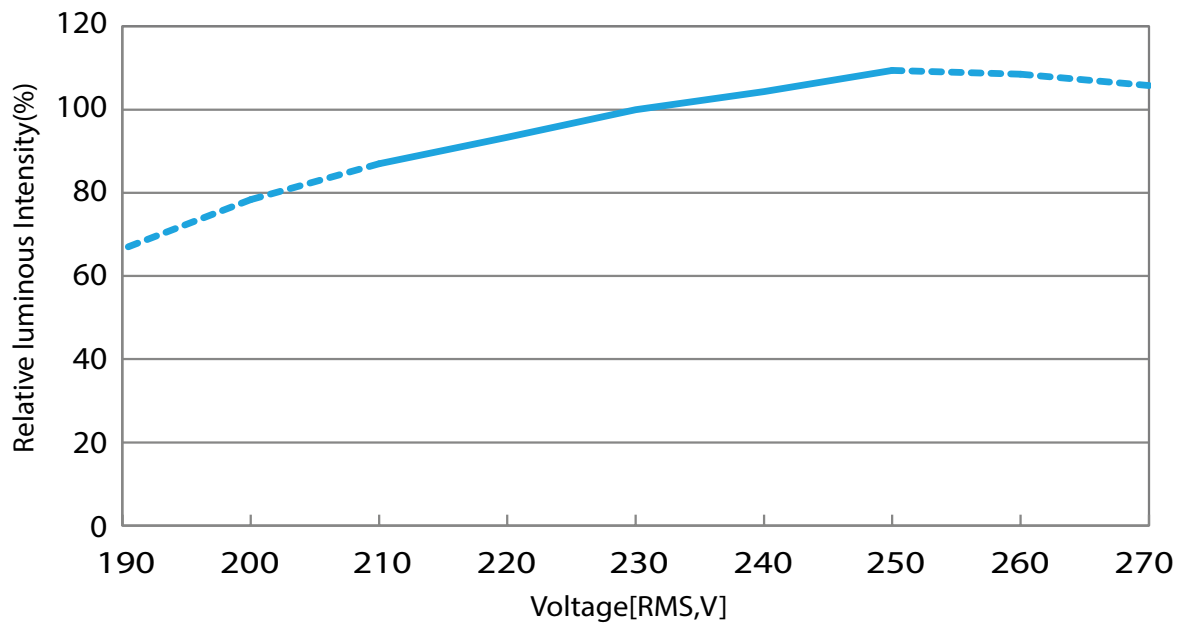

Relative Wattage vs. Voltage (Tc=25°C)

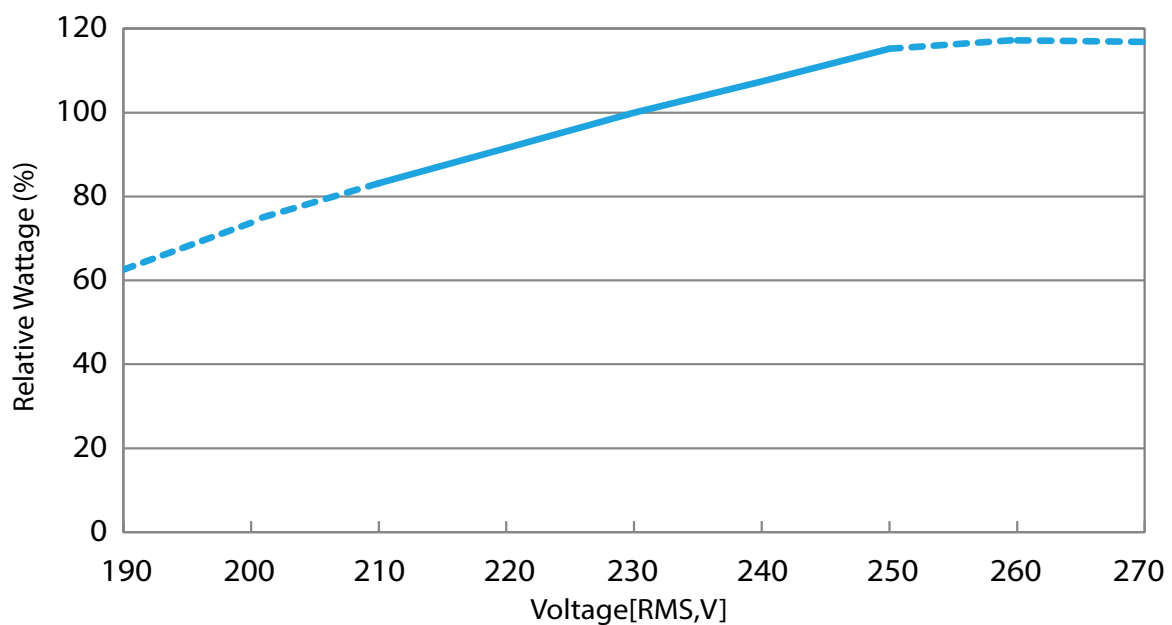

Relative Luminous Intensity vs. Case Temperature

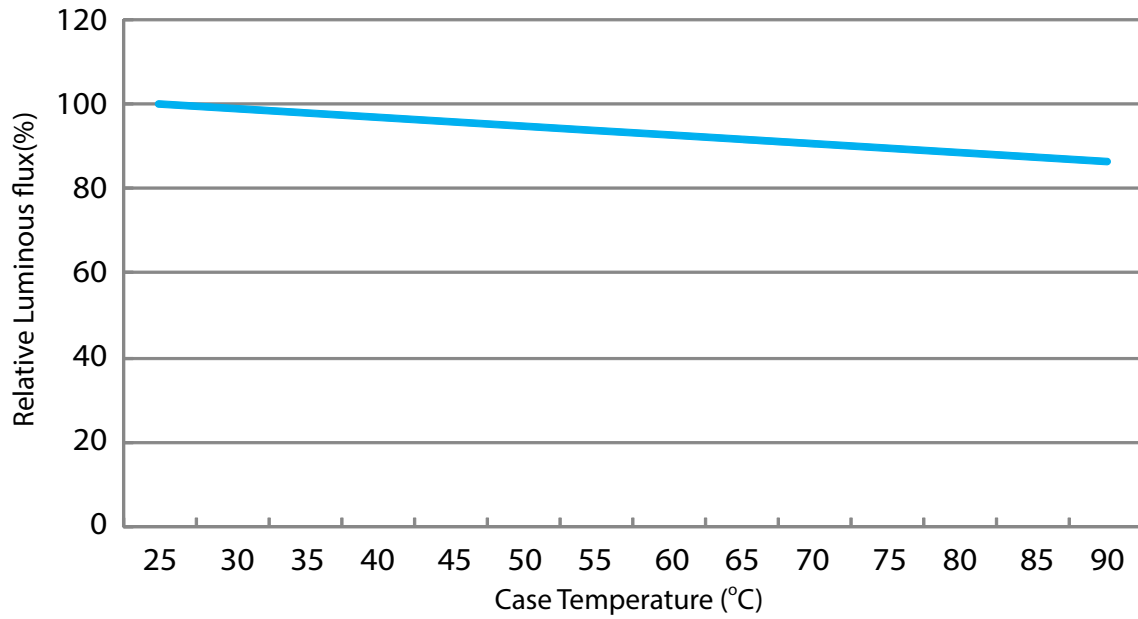

Relative Wattage vs. Case Temperature (VAC=230V)

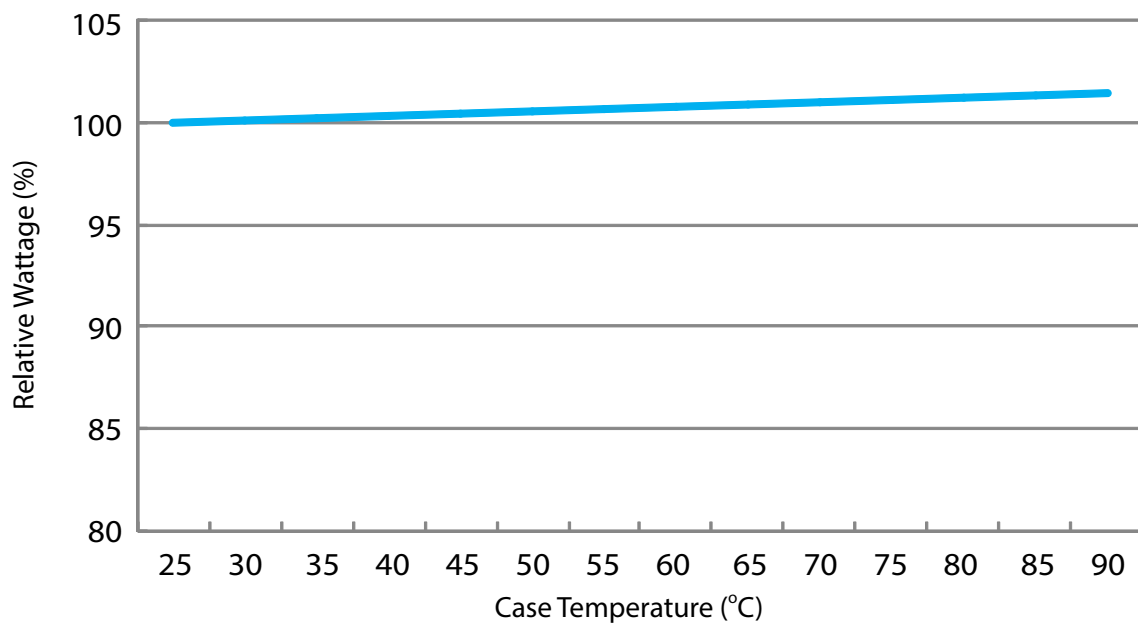

Flicker Performance (During dimming)

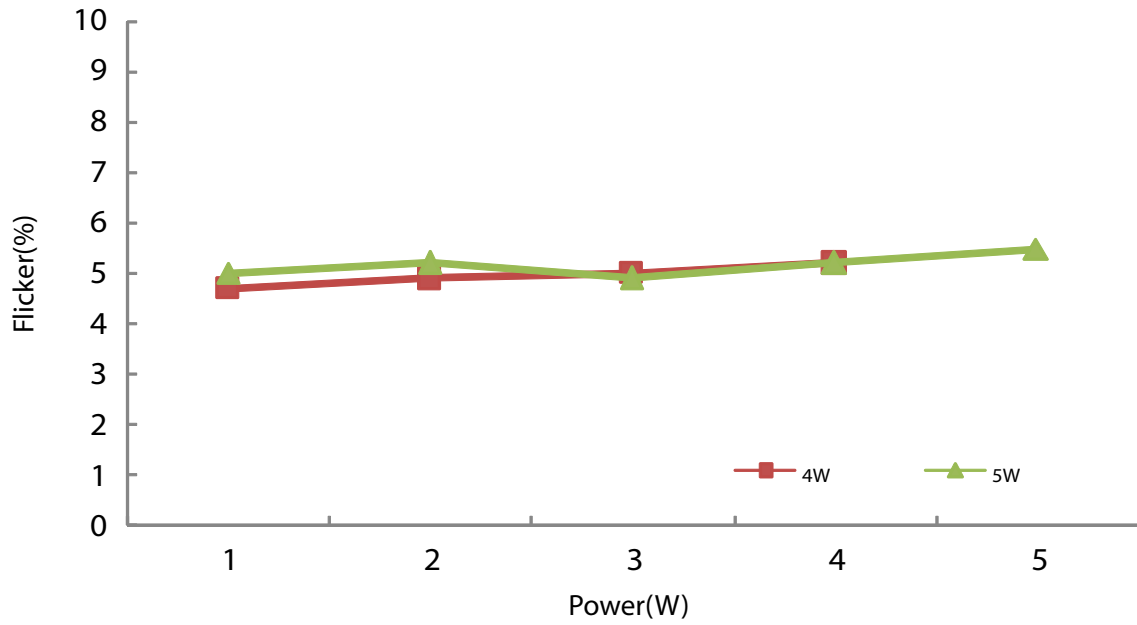

Reliability

NO .	Test Item	Test Condition	Remark
1	Temperature Cycle	-40°C~100°C (30 mins / 30 mins)	100 Cycle
2	Operation Life test	Ta = 25°C	1000 hrs
3	ON/OFF Test	3 sec ON, 3 sec OFF	15K times

Failure Criteria

Item	Criteria for Judgment	
	Min.	Max.
Luminous Flux	0.85	-
$\Delta u'v'$	-	0.006
Resistance to Soldering Heat	No dead lamps or visual damage	

Cautions

LED avoids being stored and lighted in the environment containing sulfur. Some materials, such as seals, printing ink, enclosure and adhesives, may contain sulfur, avoiding the exposure in acid or halogen environment.

Product Packaging Information

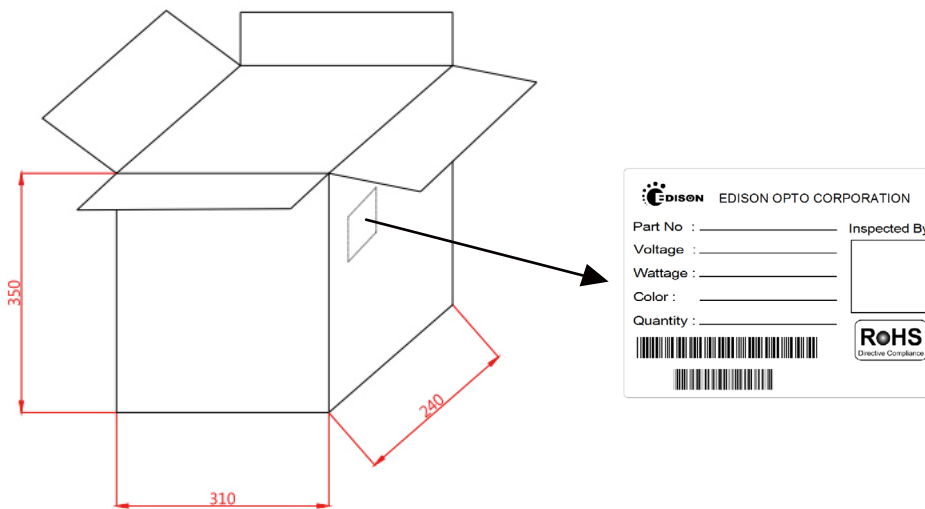
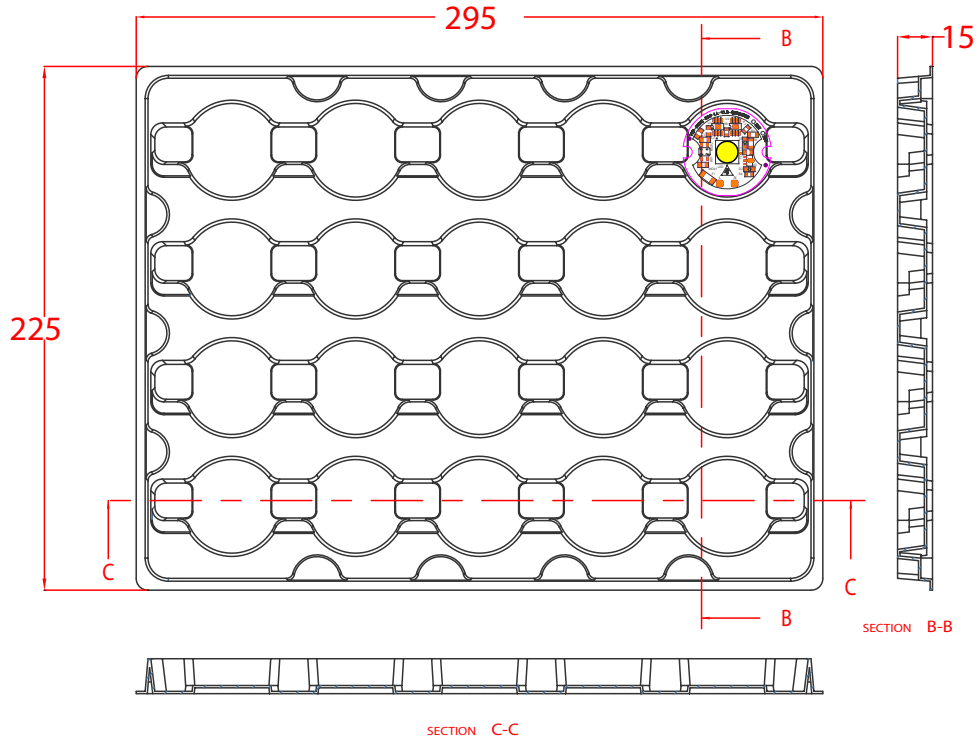

33 Tray in the outer box, 660 pcs Module in the outer box

Part No.	Number of module / Tray	Number of module /Box	Weight
5ELACN3T2304xxxx 5ELACN3T2305xxxx	20pcs	660pcs	5.5KG

Handling with a DOB Series

√ Both the light emitting area and white dam over the light emitting area is composed of resin materials. Please avoid the resin area from being pressed, stressed, rubbed, come into contact with sharp metal nail because the function, performance and reliability of this product are negatively impacted.

√ LED device are combine by many accurate parts which belong to static sensitive device. A human body may aware of the discharge voltage about 2-3KV, which is much larger than an electronic device may bear. Therefore, to keep the LED operation environment away from static and lower the exits static become an important issue in a LED manufacture.

1. Anti-Static Steps - All the staffs who has the possibility to contact with the LED components should follow the instructions to eliminate the static:

- Put on the hand or finger gloves before touch a LED device. (Do not use a nylon or rubber Glove)
- Do not do any actions that may generate the static in the protection area. Such as wipe hands or foot, put on/off the clothes.
- Avoid any movement that may cause static damages. When remove a component from the package, please be slow and gentle.
- Do not touch the metal part of a LED component.

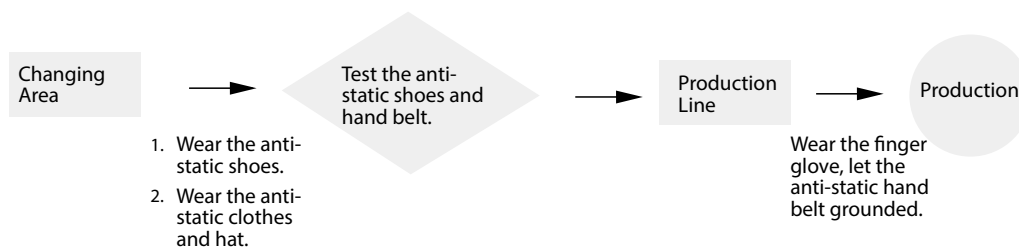

2. Environmental anti-static protection

- Use an anti-static floor and make earth. Materials such as plastic or rubber contain carbon or conductive polyester is recommended.
- LEDs should be operated on the desk which is laid by the static discharge material.
- Protection area with a temperature at $22\pm 5^{\circ}\text{C}$ and a relative humidity at $70\pm 10\%\text{RH}$ are recommended.
- Layout an appropriate earth system. All the equipment should earth isolated into the ground or pillar.
- All soldering and testing equipment should also provide earth ability.
- Prevent the accumulation and the fractions between stuffs.

3. Anti-Static steps for package, transportation and storage.

- Package: All the bags must have the ability of anti-static. Do not use any nylon bag, normal plastic bag or polyester bag for package. Do not open the bag if a LED is not ready to be handling. Open the bag at the protection area and put in a conductive case.
- Transportation: The cart should install the conductive wheels. Avoid the mechanical vibration and impacts.
- Storage: Be attention of the temperature and the relative humidity under the suggest condition.

√ Thermal Management

About 80% of input power of a LED transform into heat. A high temperature operation condition always easily causes the LEDs to decrease of flux and the life decay of LED dies. The highest operation temperature of a component is able to be found in its datasheet which is indicated as T_j .

The power dissipation ability, the ambient temperature between the LED junction, environment, thermal path and its thermal resistance are the mean parameters which affect the performance of a LED device. Therefore, the limitation of the junction temperature has become an important issue when designing a LED product.

For LEDs, choose an appropriate operation environment and conduct the heat to the air after light on LEDs may maintain the better performance and lifetime. Four major thermal path are :

- (1) From heat source (component) to heat sink. (By conduction)
- (2) Conduction from within the heat sink to its surface. (By conduction)
- (3) Transfer from the surface to the surrounding air. (By convection)
- (4) Emit heat from the heat sink surface. (By Radiation)

Path(1): The contact surface of the component and heat sink are not perfectly flat, they are not able to meet each other completely. Air between these two materials will result high thermal resistance and reduce the effect of heat transfer. To enhance the ability of thermal conduction, one common method is applying thermal grease between the two interfaces and use the screws to enforce the adhesion between two surface.

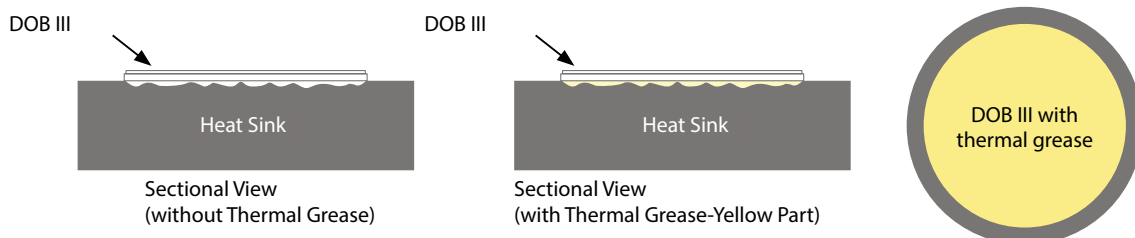

Recommended thermal Grease Parameters

Characteristics	Value	Unit
Thermal Conductivity (K)	>3.0	W/m*K
Thickness	≤0.1	mm

- √ DO NOT touch any of the circuit board, components or terminals with body or metal while circuit is active.
- √ DO NOT add or change wires while circuit is active.
- √ DO NOT make any modification on module.
- √ DO NOT use together with the materials containing sulfur.
- √ DO NOT exceed the values given in this specification
- √ Keep cautions not to apply higher voltage above the maximum rating. Otherwise damage may occur.
Pay attention not to exceed the maximum operation temperature of the Tc Point when the modules are used in an enclosed environment.
- √ DO NOT use adhesives to attach the LED that outgas organic vapor.
- √ DO NOT directly make the HI-POT test over 750V on the module.
- √ DO NOT separately connection L and N terminal when the power source turn on
- √ DO NOT wear any conductive accessories (such as jewelry) which could accidentally get an electric shock.
- √ DO NOT press the product; even a slight pressure may damage the product. The environments such as high temperatures, high humidity or direct expose to sunlight should be avoided since the product is sensitive to these conditions
- √ DOB AC Module uses integrated circuit (IC) which can be damaged when exposed to static electricity. Please operate with antistatic device. Do not touch the product unless ESD protection is used. DOB AC Module can't be installed in end product unless the ESD protection is used
- √ DO NOT assemble in conditions of high moisture and/or oxidizing gas such as Cl, H₂S, NH₃, SO₂, NO_x, etc. Damage by corrosion will not be allowed as defect claim.
- √ LED Module is recommended for Indoor use only. Longtime exposure to sunlight or UV can cause the lens to discolor.
- √ Please note that BOB AC Module products are driven by high voltage, therefore when operating DOB AC Modules should be very cautious
- √ Faults, lightning, or fast switch may cause voltage surge which surpasses the normal value
- √ The failure of internal component may cause excessive voltages
- √ Storage Precautions:
 - (1) The devices should be stored in the anti-static bag.
 - (2) If the anti-static bag has been opened, please make sure to reseal the bag to avoid air and moisture infiltrate in the bag.

Revision History

Versions	Description	Release Date
1	Establish a Datasheet	2021/06/23
2	Add Holder Dimensions	2021/10/19

About Edison Opto

Edison Opto is a leading manufacturer of high power LED and a solution provider experienced in LDMS. LDMS is an integrated program derived from the four essential technologies in LED lighting applications- Thermal Management, Electrical Scheme, Mechanical Refinement, Optical Optimization, to provide customer with various LED components and modules. More Information about the company and our products can be found at www.edison-opto.com

Copyright©2021 Edison Opto. All rights reserved. No part of publication may be reproduced or transmitted in any form or by any means, electronic or mechanical, including photo copy, recording or any other information storage and retrieval system, without prior permission in writing from the publisher. The information in this publication are subject to change without notice.

www.edison-opto.com

For general assistance please contact:
service@edison-opto.com.tw

For technical assistance please contact:
LED.Detective@edison-opto.com.tw