

# LightMAX

R0B73

18 power LED module

**7** YEARS WARRANTY



**CC** CONSTANT CURRENT

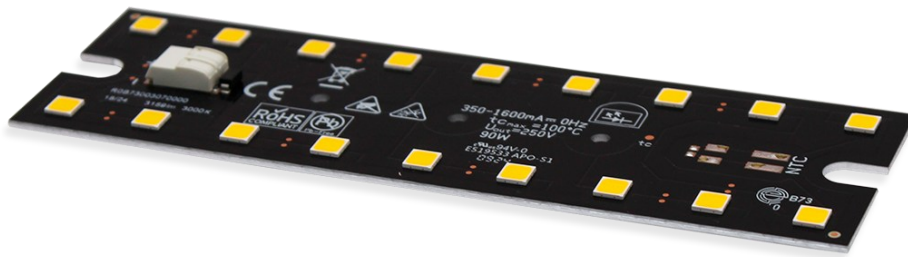

## FEATURES

- PCB dimension:147x45mm
- Up to 9096 lm
- Up to 185 lm/W
- CRI 70
- Max Electrical Insulation 250V
- Max 4 LED boards in series
- Connection type: Wago 2060 2 pole
- Lifetime >100.000h @ 700mA<math>I\_{f}</math><math><1050\text{mA}</math> L90B10

## APPLICATIONS



Street



Industrial

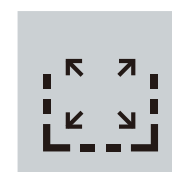

Area

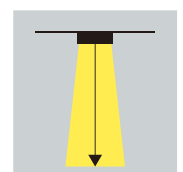

High Bay

# LightMAX

R0B73

18 power LED module



**7** YEARS WARRANTY

**CC** CONSTANT CURRENT

Code	CCT	CRI	Current [mA]	Voltage [V]	Power [W]	Total Lumen [lm]	Lm/W	Energy Efficiency
R0B73002770	2700K	70	700	50.6	35.4	6226	176	C
			1000	51.9	51.9	8647	167	D
R0B73003070	3000K		700	50.6	35.4	6469	183	C
			1000	51.9	51.9	8984	173	C
R0B73004070	4000K		700	50.6	35.4	6550	185	C
			1000	51.9	51.9	9096	175	C
R0B73005070	5000K		700	50.6	35.4	6550	185	C
			1000	51.9	51.9	9096	175	C

Flux tolerance +/- 10%  
Vf Tolerance +/- 5%

Ask for more information about available LED and other options.

LED and board features	
LED number	18
LED type	5050
Circuit	S9P2
Material	MCPCB
Solder	Black or White (on request)
Connections	
Cable	Solid 0,2-0,8mm2 Strand 0,45-0,7mm2
Connector	1x Wago 4mm 2 pole (2 WITH NTC option)
Power	
Abs. Max Input current CC	1600mA
Mechanical Data	
L x H	147x45mm
Thickness	6.1mm
Conditions	
Max. temp. (Tp)	+110°C
Max. temp. (Tc)	+100°C
Operating temp. Range	-40 +65°C

# LightMAX

R0B73

18 power LED module

7 YEARS WARRANTY



CC CONSTANT CURRENT

## MECHANICAL DRAWING

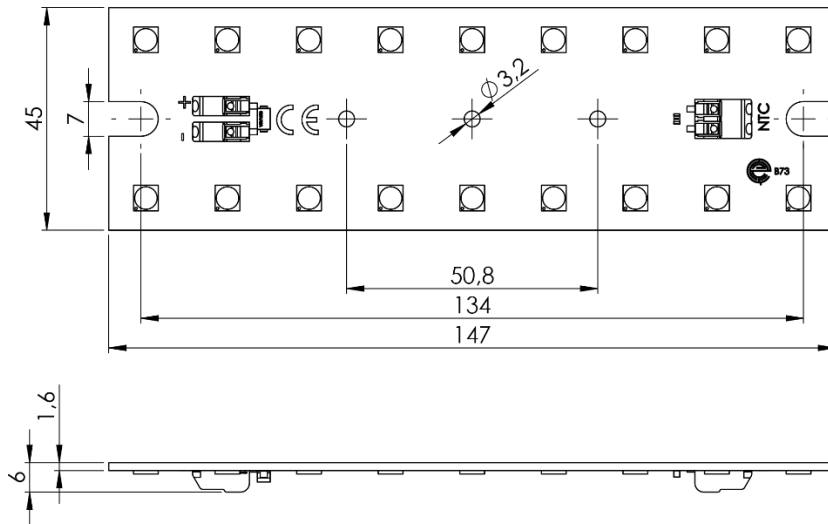

## ELECTRICAL CIRCUIT

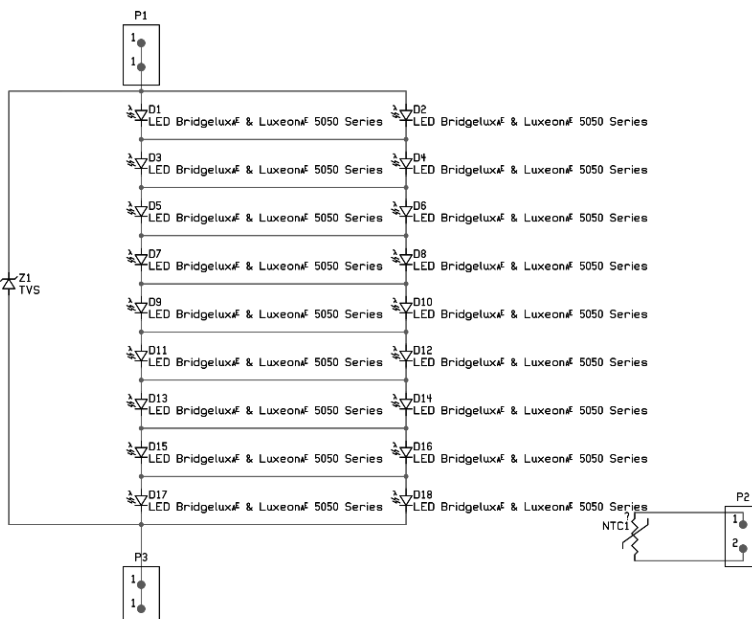

# LightMAX

R0B73

Accessories



**7** YEARS WARRANTY

**CC** CONSTANT CURRENT



<b>LED optics:</b> DZR series + Waterproof Gasket	
View Angle (Fwhm)	60° / 90° / 150° / 55°x145°
Dimension (LxW) - Type	173x71.4mm - 18in1
Material - Operating temperature	PMMA: -40°C~+70°C / PC: -40°C~+110°C
Efficiency	> 90%
<b>Thermal interface:</b> IREPAD-147X45	
Dimension/Thickness	147x45mm – 0,23mm
Thermal conductivity	1,5 W/mK
<b>Heat sink:</b> HS-ANOD-168-G2	
Dimension	200x70x40mm
Material	Anodized aluminium
Thermal wattage	70W
<b>Power supply:</b> BLD-075-C	
Dimension (LxWxH)	158x68x33,5mm
Protection type	IP67
Output	75W
Input	90-305Vac

# LightMAX

R0B73

Accessories



7 YEARS WARRANTY

CC CONSTANT CURRENT

## IP 18 Relamping Kit

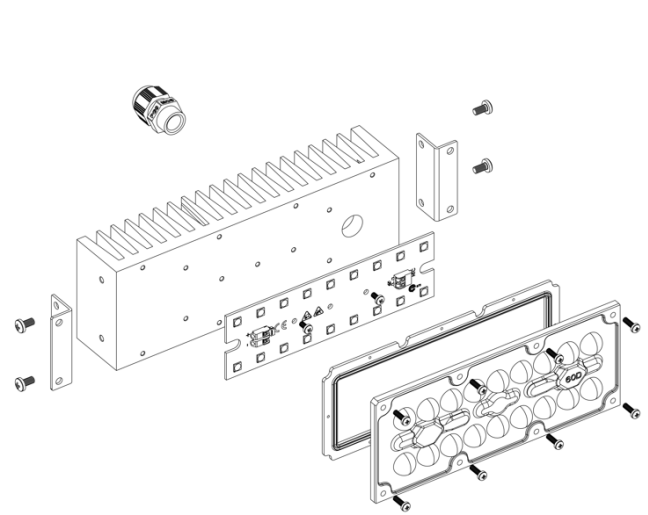
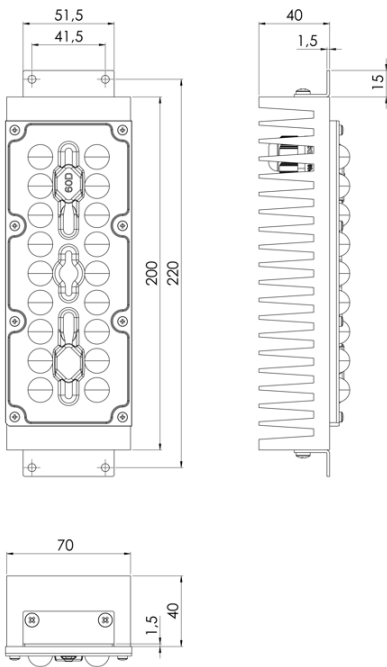

## ASSEMBLY AND SAFETY INFORMATION

The LED modules are designed to be incorporated in a final appliance. Installation must be carried out under observation of the relevant regulations and standards. Installation must be carried out in a voltage-free state (i.e. disconnected from the mains). Additionally, the following advice must be observed; non-observance can result in electrical, mechanical and/or fire hazards.

- ESD (electrostatic discharge) protection measures must be observed when handling and installing the LED modules.
- Transient protection measures (as per IEC 61000-4-5), especially for outdoor applications, must be observed (e.g. SPD).
- Adequate anti-static electricity measures, including the use of conductive shoes, ionizers, work bench grounding, wrist straps, flooring and stools should be used.
- LED assembly modules must not be subjected to any undue mechanical stress, e.g.:
  - Do not treat as bulk cargo.
  - Avoid sharing and compressive forces during handling and installation.
  - Do not damage circuit paths.
  - Avoid any pressure on the light emitting surface.
- Safe operation is only possible using proper external sources (e.g: constant current sources - I<sub>max</sub>. see table "Electrical Characteristics").
- Operate only with power supply units that feature the following protection:
  - Short-circuit protection
  - Overload protection
  - Overheating protection
- The module can be fixed with M3 screws. They are recommended to be fixed only with flat or cylinder head screws (M3) (no countersunk screws – if not differently specified). Max. torque: 1.2 Nm (M3)
- Please ensure the correct polarity of the leads prior to applying power. Reversed polarity can destroy the modules.
- For interconnection, the LED modules are usually equipped with push-in terminals. Custom connectors are available upon request during the project bidding stage.
- General Safety regulations acc. to IEC/EN 60598-1 (or specific standards related to different lighting applications) must be observed.
- The following points must be observed when connecting LED modules in parallel:
  - All LED strings that are wired in parallel must contain the same number of LEDs (symmetrical loading).
  - Owing to differing forward voltage, there can be a difference of up to 10% in brightness between modules connected in parallel.
  - For this installation setup, please notify us when placing your order.
- To ensure problem-free operation, the specified maximum temperature at the tp point (see "Operating Life") must be observed (and measured in accordance with IEC 62717 – Annex H).
- In the event of outdoor applications or applications in damp locations, care must be taken to protect LED modules against humidity, splashes and jets of water. Any corrosion damage resulting from humidity or contact with condensation will not be recognized as a defect or manufacturing fault. LED modules are not specifically protected against foreign bodies or dust. Depending on the type of application, further protection must be provided to prevent ingress.
- Due to the manufacturing process, the PCBs of the LED modules can have sharp edges and corners. Care must therefore be taken during handling and installation to avoid injury.
- Constant current drivers require for an optimal usage that the modules are connected in series. For this type of usage, there must be ensured that the quantity of LED modules is limited by the sum of forward voltage and the capacity of used constant current driver. Safety regulations acc. to IEC/EN 60598 must be observed if the sum of forward voltage exceeds the permitted touchable value.
- There is a list of chemical substances (as sulfur) that has been proved to make the LED module damaged. Also, in chemically enriched (aggressive) environments the LED module functionality can be compromised, or they can even cause total module failure. Keep attention to this aspect before installing the LED module.
- The photobiological safety of the LED modules must be classified into risk groups in accordance with IEC/EN 62471 and IEC/EN 62471-7.

## APPLIED STANDARDS

IEC / EN 62031  
LED modules for general lighting – Safety specifications

IEC 62717  
LED modules for general lighting - Performance requirements

IEC/EN 60598-1  
Luminaires – Part 1: General requirements and tests

IEC/EN 62471  
Photobiological safety of lamps and lamp systems

IEC 61000-4-5  
Electromagnetic compatibility (EMC) – Part 4-5: Testing and measurement techniques – Surge immunity test